

MINING CABLES



TF
Kable



TABLE OF CONTENTS

MINING CABLES	2	SOUTH AFRICAN STANDARDS SANS	
TELE-FONIKA KABLE	3	TYPE 41 640/1100 V	110
PRODUCTION POTENTIAL	5	TYPE 63 1.9/3.3 kV	112
REFLECTIVE MINING CABLES		TYPE 66, 66ECC 3.8/6.6 kV	114
SHD-GC 2/0 AWG 2 kV	7	TYPE 611, 611ECC 6.35/11 kV	116
MINING FLEXIBLE CABLE 640/1100 V	9	TYPE 622, 622ECC 12.7/22 kV	118
TYPE 61A FLEXIBLE 640/1100 V	11	TYPE 633, 633ECC 19/33 kV	120
TYPE 66, 66ECC 3.8/6.6 kV	12	MINING FLEXIBLE CABLE 640/1100 V	122
TYPE 611, 611ECC 6.35/11 kV	14	AUSTRALIAN/NEW ZEALAND STANDARDS AS/NZ	
VDE STANDARDS AND (HD) HARMONIZED STANDARDS		TYPE 209 1.1 to 11 kV	126
OPEN PIT MINES		TYPE 240 1.1 to 11 kV	129
R-(N)TSCGEWÖU 3.6/6 to 18/30 kV	18	TYPE 241 1.1 to 11 kV	132
F-(N)TSCGEWÖU 3.6/6 to 18/30 kV	23	TYPE 275 1.1/1.1 kV	135
NTMCGCWÖU 3.6/6 to 18/30 kV	27	TYPE 409 1.1 to 22 kV	136
NSHTÖU-J 0.6/1 kV	29	TYPE 440 1.1 to 22 kV	139
NSSHÖU 0.6/1 kV with individual core screen	33	TYPE 441 1.1 to 22 kV	142
NSSHÖU 0.6/1 kV with individual core screen and pilot conductor	35	TYPE 450 3.3 to 33 kV	146
(N)TMCGETMPU 6/10 to 14/25 kV	37	TYPE 455 3.3 to 33 kV	149
(N)TMCETMPU 6/10 to 14/25 kV	39	TYPE 25 0.6/1 kV	152
(N)TMH3S 0.6/1 kV	41	MINING TELECOMMUNICATION CABLES	
(N)TSKCGEWÖU 3.6/6 (7.2) kV	43	COPPER TELECOMMUNICATION CABLES	
NTSKCGWÖU 0.6/1 (1.2) kV	46	TCEKEY	158
NTSKCGWÖU 0.6/1 (1.2) kV KON	48	TCEKFY	160
RIT-(N)TMCGETMPU 6/10 to 14/25 kV	50	TCEKFLEY	162
TRM-J 0.69/1.15 kV	52	TCEPKPFLEY	164
CZECH AND POLISH STANDARDS		TCEKFLEDY	166
OPEN PIT MINES		YnTKGMLY TEX	168
CHCU-TT 6 kV	56	YnTKGX	169
CHBU 1, 3, 6 kV	59	4GTL3Gekwn-G	170
OnGcekzi-G 0.6/1kV	61	YTKGXFoyN, YTKGXFtlyn, YTKGXFtyn	172
OnGcekz-G, OnGcekz-GW 0.6/1 kV	63	FIBER OPTIC CABLES	
OnGcekz-G2, O2nGcekz-G2 0.6/1 kV	65	YOTKGtsDFoyN	174
OnGcekz-G 3.6/6 kV	66	YOTKGtsFoyN	176
UNDERGROUND MINES		YOTKGtsDFtlyn	178
CBEH 0.6/1 kV	68	ZW-(QG)GNOTKSdD	179
CYKYDY 0.6/1 kV	70	PSKD	181
CHKCYDY 6 kV	71	YOTKGtsFtlyn	183
CYKYDY 6 kV	72	TUNNELING CABLES	
O2nGcekz/w-G(A) 1.9/3.3 kV	73	(N)3GHSSYCY	186
O2nGcekz/w-G(W) 3.6/6 kV	76	CABLE DRUMS	
YHKGyFoyN 3.6/6kV	78	Sample data for wooden cable drums	187
YKGYFoyN 3.6/6kV	80	PICTOGRAMS	
YnÖGYek	81	Description of pictograms used in catalogue	188
YnÖGYekm	83		
AMERICAN/CANADIAN STANDARDS ICEA/NEMA/CSA			
SHD-GC 2, 5 kV	86		
SHD-GC 8, 15, 25 kV	89		
SHD-CGC FOM 5 kV	93		
SHD-PCG 2 kV	95		
SHD-PCG 5 kV	97		
SHD-PCG 8 kV	100		
MP-GC 5, 8, 15, 25 kV	102		
TYPE W, 1 to 5 cores 2000 V	105		

NEW!!

MINING CABLES

TELE-FONIKA Kable is the biggest cable producer in Central and Eastern Europe. In scope of mining cables production, TELE-FONIKA Kable is a leader in Poland and doesn't give way to other European and world's producers.

For production of mining cables, TF Kable has over a dozen various production lines of continuous vulcanization, twisters, braiders, etc. CV lines have possibility of extrude up to three layers of rubber in one operation, and instrumentation which allows to control production process, and finish goods parameters. TF Kable produces also mining cables in polyurethane sheath, which is one of the best tear resistant material. TF Kable produces cables according not only to Polish but also other national standards, such as DIN VDE (German), BS (British), ICEA i ASTM (American), NF C (French), SANS (South African), GOST (Russian) and many others including harmonized standards widely used throughout Europe and elsewhere. Many years of experience in cables production allowed for developing materials that meet various requirements. Cables working in hard conditions such as mines, have rubber sheaths which are flame retardant, rending, tear and abrasion resistant, water, oils and other chemicals resistant. Cables are designed to ensure the longest and the safest operation in heavy duty conditions in mines and other heavy industries.

All mining cables can be tailored to specific features. Optical fiber, pilot and monitoring cores are just three of the numerous additions our customers may incorporate to reach their optimum solution. In addition, our trailing cables and coal cutter cables ensure power supply despite difficult operating conditions in the mines such as excessive material strain, extraordinary climatic conditions and risk of explosion.

You can be assured of performance when mining cables, manufactured by TELE-FONIKA Kable, are installed in numerous mines all over the world.



TELE-FONIKA Kable

The Group TELE-FONIKA Kable (TF Kable) is ranked in the forefront of the global cable industry. The Group is the third manufacturer of cables and wires in Europe with significant development potential, based entirely on Polish capital.

TELE-FONIKA Kable Group's considerable investment in research and development centers and multi-skilled work teams, which have included eminent scientists working with our specialists, has been rewarded by the introduction of new-generation products and comprehensive services in the field of cable engineering. Products manufactured in our plants are sold in over 90 countries. Our product assortment includes 25 thousand cable types. The highest quality of our products is confirmed by over 460 certificates for groups of wares licensed by 34 renown centres of certifications worldwide. The company combines the good traditions of the cable industry in Poland and innovative technical solutions. TELE-FONIKA Kable Group consists of six plants — four in Poland, one in Ukraine, and one in Serbia. We own over a dozen trade agencies abroad, reaching customers in several dozen countries around the world.



Experience
and
innovation



PRODUCTION POTENTIAL

Our chief asset is extensive technological know-how in the field of production of wide variety of cables and wires supported by our experienced personnel. Our products match to a great extent the general trends concerning ecology and maintenance safety of wares. Extremely strict legislation in these areas has become the indicator of the technological progress of the manufactured cables.

Krakow-Wielicka Plant

Krakow-Wielicka Plant was established in 1928. In 1992, it received the ISO 9002 certificate (now ISO 9001) and in 1998 the ISO 14001 given by the British certification body: BASEC. The plant specializes in the production of rubber insulated cables and wires for mining and industrial applications. All types of rubber mixes used for EPR, CR, EVA and CSP cables are based on an original prescription designed together with research and development centres. The production offer of the plant are also medium voltage cables made in XLPE technology, as well as signal and control wires for special purposes.

Krakow-Biezanow Plant

Krakow-Biezanow Plant was established in 2001. In 2002, it received the ISO 9001 certificate and 14001 given by the British certification body: BASEC. The plant specializes in the production of overhead conductors from alloyed aluminium, conductors for railway traction network from copper and its alloys and installation wires for general usage.

Bydgoszcz Plant

Bydgoszcz Plant started production of cables and wires back in 1923. In 1992, it received the ISO 9002 certificate (now ISO 9001) and in 1998 the ISO 14001 given by the British certification body: BASEC. Bydgoszcz Plant specializes in power supply cables of medium and high voltage up to 400 kV. It is equipped with six modern chain lines for crosslinking polyethylene in XLPE technology. Complementary technological lines for producing the abovementioned cables ranging from thick wire drawing machines, cable stranding machines and screening machines to covering lines and two large-size high voltage laboratories called "Faraday cage" place the plant in the top of the list of the largest production centres of medium and high voltage cables in Europe.

Myslenice Plant

Myslenice Plant was established in April 1992 under the name Zakłady Kablowe TELE-FONIKA s.c. In 1995, it received the ISO 9001 certificate and in 1999 the ISO 14001 certificate. The certification body is BASEC. In September 2007 the plant received the ISO/TS 16949 certificate for automotive cables given by the certification body: SGS. Myślenice Plant specializes in the production of copper and fibre optic telecommunication cables, computer cables and automotive wires.

TOW TF Kabel (Ukraine)

The plant was established in 2002. In 2007, the plant was joined into the TELE-FONIKA Kable Group. This Plant is certified according to ISO 9001 and 14001. It specializes in the production of overhead conductors and cables for voltage up to 1 kV, including halogen-free, fire resistant and flame retardant cables versions.

TF Kable Fabrika Kablova Zajecar A.D. (Serbia)

The plant was established in 1974. In 2007, the plant was joined into the TELE-FONIKA Kable Group. This plant is certified according to ISO 9001 and 14001 by DAS Certification Ltd. It specializes in the production of low and medium voltage cables, as well as halogen-free, fire resistant and flame retardant cables, telecommunication cables and PVC and polyethylene-coated conductors.

REFLECTIVE MINING CABLES

SHD-GC 2/0 AWG 2 kV	7
MINING FLEXIBLE CABLE 640/1100 V	9
TYPE 61A FLEXIBLE 640/1100 V	11
TYPE 66, 66ECC 3.8/6.6 kV	12
TYPE 611, 611ECC 6.35/11 kV	14

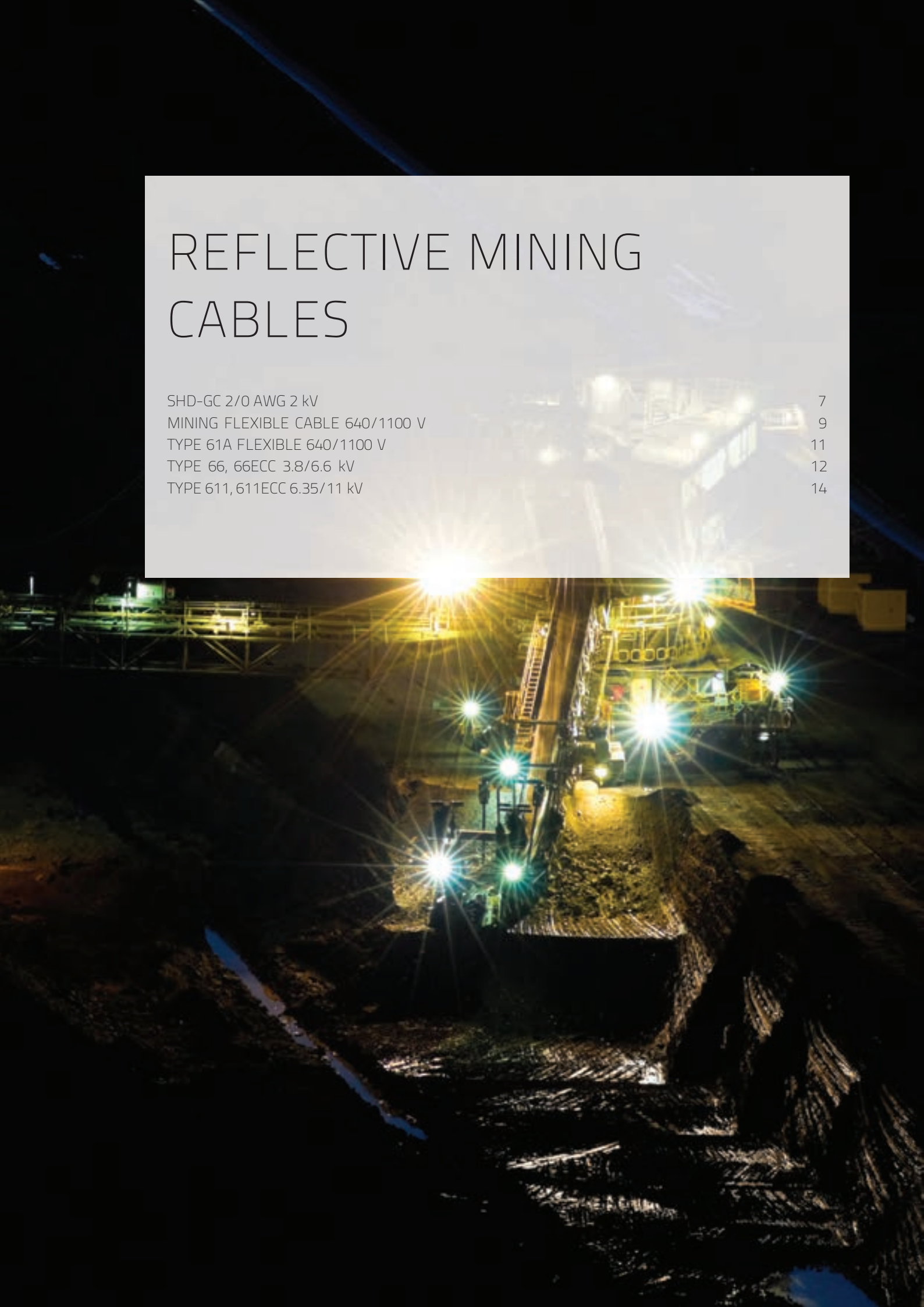

SHD-GC 2/0 AWG 2 kV



Round portable power cables, mining grade

Standards: based on ICEA S-75-381/NEMA WC-58

CONSTRUCTION

Conductors	Annealed flexible stranded tin coated copper in accordance with ASTM B 172 and ICEA S-75-381 ,Tab. 3-22.
Conductor shield	Semi-conductive layer over the conductor
Insulation	Ethylene-propylene rubber (EPR)
Insulation shield	None-conducting bedding tape +Composite tinned copper/polyamide braid. Coverage minimum 60%
Circuit identification	The polyamide in the shielding braid is coloured black, white, red in accordance with ICEA S-75-381
Grounding	Annealed tin coated copper acc. Tab. 3-25 of ICEA S-75-381
Ground check	Yellow polypropylene - insulated tinned copper conductor. Size 8 AWG
Assembly	Three power, the ground check, two non-insulated grounding cabled together to form a round cable core
Separator	A single faced rubber filled binder tape applied over core
Outer jacket	Extra heavy duty, integral-filled , TPU jacket, ICEAS-75-381 Tab. 3-3.
Colour of outer jacket	Transparent with orange/silver reflective tape under TPU jacket
Minimum bending radius	Eight times overall diameter of the cable
CHARACTERISTICS	
Excellent flexibility	
Highly ozone, sun, weather and flame resistant	
Rated and flexible at -40°C	
Excellent impact and abrasion resistant	
Oil and heat resistant	
Indent printed for easy identification	
Application	Used for heavy mobile equipment such as draglines, shovels, dredges, drills and other track equipment etc.
Standard length cable packing	500 m on drums. Other forms of packing and delivery are available on request
Approvals	MSHA: P-07-KA030001

Selection data											
Power conductor size	Power conductor stranding		Nominal thickness of insulation	Jacket thickness	Grounding conductor			Approximate weight		Approximate overall diameter	Maximum permissible tensile force
					Size	Stranding					
AWG or MCM			Inches	Inches	AWG			lbs./1000 ft	kg/km	Inches	N
2/0	342	19x18	0.080	0.0205	3	259	7x37	2933	4365	2.00 ^{-5%+8%}	3000

Electrical parameters							
Power-grounding conductor size	Power conductor resistance at 25°C	Grounding conductor resistance at 25°C	Ground-check conductor resistance at 25°C	Inductance per unit length	Operating capacitance per unit length	Permissible short-circuit current ^{*,**}	Ampacity [*] 40°C ambient temperature
AWG or MCM	Ω/1000 ft	Ω/1000 ft	Ω/1000 ft	mH/1000 ft	μF/1000 ft	kA	A
2/0 AWG	0.0868	0.227	0.679	0.092	0.16	9.64	243

* Ampacity –Based on continuous duty at 90°C conductor temperature

** Short-circuit current^{*} – Based on conductor temperature from 90°C up to 250°C

STANDARD PRINT LEGEND:

TF KABLE 3 (VOLTAGE)(SIZE) TYPE SHD-GC FT1 FT5+90°C MSHA:P-07-KA030001

Other sizes available upon request

MINING FLEXIBLE CABLE TRACKLESS SCOOP 640/1100 V

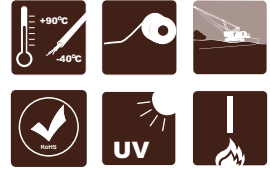

Flexible, copper screened rubber insulated and sheathed cables	
Standards: based on SANS 1520-1	
CONSTRUCTION	
Conductors	Flexible class 5 comply to SANS 1411-1 from tinned annealed copper wires
Separator	A suitable tape separator between the conductor and insulation
Insulation	Ethylene propylene thermosetting compound type RD 6 comply to SANS 1411-3
Core of cable	Three tinned copper/nylon braid screened power cores and two unscreened pilot core and one tinned earth conductor laid up in the right hand lay around rubber type RD1 dummy centre
Outer sheath	Extra-heavy duty TPU jacket acc. to ICEA S-75-381 Tab. 3-3
Colour of outer sheath	Transparent with orange/silver reflective tape under TPU jacket
Marking type	Ink-jet/Black or Conver/Embossed
CHARACTERISTICS	
Excellent flexibility	
Water resistant and flame retardant	
Temperature range -25°C to +90°C. For fixed installation lowest temperature is -40°C	
UV, sunlight, ozone and oil resistant	
Legible and indelible ink jet or embossing (for 25 mm² and larger) marking as per order	
Application	Submersible pumps, on board wiring for machines Single, double, triple drilling rigs, loaders, low haulage dumpers, loaders, large drilling rigs Other industrial applications
Standard length cable packing	1000 m on drums. Other forms of packing and delivery are available on request

Table 1

Physical properties	
Power cores	
Conductor sizes (mm ²)	35
Maximum wire diameter (mm)	0.41
Approximate conductor diameter (mm)	8.5
Maximum screen wire diameter (mm)	0.31
Braided screen filling factor (%)	80
Approximate summarized screen cross-section for power cores - weighting method (mm ²)	27
Pilot cores	
Number of pilot cores	2
Conductor sizes (mm ²)	6
Maximum wire diameter (mm)	0.31
Approximate conductor diameter (mm)	4.2
Earth cores	
Number of earth cores	1
Conductor sizes (mm ²)	16
Maximum wire diameter (mm)	41
Approximate conductor diameter (mm)	5.3
Lay Ratio (maximum) (x PCD)	8
Cable diameter	
Minimum (mm)	37.0
Maximum (mm)	40.0
Cable mass (approx.) (kg/m)	2.74
Minimum bending radius (mm)	320
Maximum recommended tension (kN)	1.73

Other sizes available upon request

Table 2

Electrical properties	
Power cores	
Maximum cond. DC resistance at 20°C (Ω/km)	0.610
Maximum cond. DC resistance at 90°C (Ω/km)	0.814
Reactance (Ω/km)	0.090
Impedance (Z) at 90°C (Ω/km)	0.819
Sustained current rating at 30°C ambient	
Laid out straight (A)	181
1 layer on drum (A)	151
2 layer on drum (A)	121
3 layer on drum (A)	81
Short circuit rating	
Symmetrical fault current (kA for 1 sec)	4.0
Earth fault current - screens (kA for 1 sec)	2.1

TYPE 61A FLEXIBLE 640/1100 V

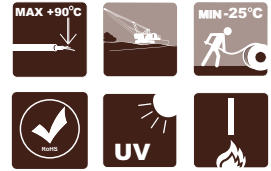

Flexible electric trailing cables for use in mines	
Standards: based on SANS 1520-1	
CONSTRUCTION	
Conductors	Flexible class 5 comply to SANS 1411 - 1 from tinned annealed copper wires left lay
Insulation	Ethylene propylene thermosetting compound type RD 3 comply to SANS 1411-3
Core of cable	Three tinned copper braided screened power cores and three unscreened pilot cores one in each interstice laid up in the right hand lay around semi-conductive cradle centre (only 16 mm ² around rubber (RD1) filler centre)
Outer sheath	Extra-heavy duty TPU jacket acc. to ICEA S-75-381 Tab. 3-3
Colour of outer sheath	Transparent with orange/silver reflective tape under TPU jacket
Marking type	Ink-jet/Black or Convex/Embossed
CHARACTERISTICS	
Excellent flexibility	
Abrasion, tear resistant and flame retardant	
Minimum ambient temperature -25°C, maximum conductor temperature 90°C	
UV, sunlight, ozone and oil resistant	
Application	Electrically driven machines, movable electric apparatus in hazardous areas. Not suitable for reeling purposes
Standard length cable packing	500 m on drums. Other forms of packing and delivery are available on request

Conductor size	Power cores					Pilot cores			Lay ratio	Approx. cable dia.	Cable mass	Min. bending radius	Max. recommended tension
	Max. wire dia.	Approx. conductor dia.	Max. screen wire dia.	Braided screen filling factor	Approx. summarized screen cross-section	Conductor sizes	Max. wire dia.	Approx. conductor dia.					
mm ²	mm	mm	mm	%	mm ²	mm ²	mm	mm	x PCD	mm	kg/km	mm	kN
95	0.51	13.5	0.31	80	43	16	0.41	5.3	8	59.1	6.34	350	4.3

Other sizes available upon request

TYPE 66 3.8/6.6 kV

TYPE 66 ECC 3.8/6.6 kV

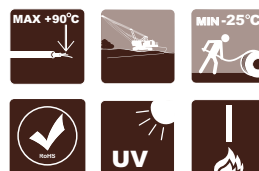

Flexible copper screened mining cables	
Standards: based on SANS 1520-2, ICEA S-75-381	
CONSTRUCTION	
Conductors	Flexible class 5 comply to SANS 1411-1 from tinned annealed copper wires, left hand with semi-conducting rubber screen
Insulation	Ethylene propylene thermosetting compound type RD 3 comply to SANS 1411-3 and a strippable semi-conducting core screen (triple extruded)
Insulation screen	Tinned copper wires/synthetic fibre braid
Cable assembly	Three tinned copper/nylon braid screened power cores and three unscreened pilot cores one in each interstice laid up in the right hand lay around semi-conductive filler centre. (Alternatively, one pilot can be replaced with a tinned ECC conductor)
Outer jacket	Extra-heavy duty TPU jacket acc. to ICEA S-75-381 Tab. 3-3
Colour of outer jacket	Transparent with orange/silver reflective tape under TPU jacket
Marking type	Ink-jet/Black or Conver/Embossed
CHARACTERISTICS	
Maximum conductor operating temperature: +90°C	
Maximum conductor temperature during short circuit: +250°C	
Lowest ambient temperature of mobile systems: -25°C	
Voltage test: 8 kV	
Flame retardant: IEC 60332-1-2	
Oil resistance: IEC 60811	
Excellent flexibility	
Abrasion and tear resistant	
UV, ozone & oil resistant	
Application	Electrically driven machines, movable electric apparatus in hazardous areas, portable electric apparatus. Section feeders. Open cast mining, medium sized draglines, shovels and drills. Suitable for reeling purposes. Other industrial applications
Standard length cable packing	500 m on drums. Other forms of packing and delivery are available on request

Table 1

Physical properties	
Power cores	
Conductor sizes (mm ²)	120
Maximum wire diameter (mm)	0.51
Approximate conductor diameter (mm)	15.5
Maximum screen wire diameter (mm)	0.31
Braided screen filling factor (%)	60
Approximate summarized screen cross-section for power cores - weighting method (mm ²)	41
Pilot cores	
Conductor sizes (mm ²)	16
Maximum wire diameter (mm)	0.41
Approximate conductor diameter (mm)	5.3
ECC size (mm ²)	70
ECC maximum wire diameter (mm)	0.51
Cable info	
Lay Ratio (maximum) (x PCD)	20
Approximate cable diameter (mm)	70
Approx. cable mass. (kg/km)	8181
Minimum bending radius (mm)	590
Maximum recommended tension (kN)	5.4

Other sizes available upon request

TYPE 611

TYPE 611 ECC 6.35/11 kV

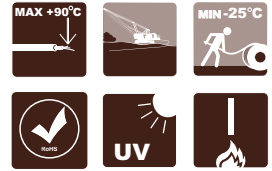

Flexible copper screened mining cables	
Standards: based on SANS 1520-2, ICEA S-75-381	
CONSTRUCTION	
Conductors	Flexible class 5 comply to SANS 1411-1 from tinned annealed copper wires, left hand with semi-conducting rubber screen
Insulation	Ethylene propylene thermosetting compound type RD 3 comply to SANS 1411-3 and a strippable semi-conducting core screen (triple extruded)
Insulation screen	The braid of tinned copper wires
Cable assembly	Three tinned copper/nylon braid screened power cores and three unshielded pilot cores one in each interstice laid up in the right hand lay around semi-conductive filler centre. (Alternatively, one pilot can be replaced with a tinned ECC conductor)
Outer jacket	Extra-heavy duty TPU jacket acc. to ICEA S-75-381 Tab. 3-3
Colour of outer jacket	Transparent with orange/silver reflective tape under TPU jacket
Marking type	Ink-jet/Black or Conver/Embossed
CHARACTERISTICS	
Maximum conductor operating temperature: +90°C	
Maximum conductor temperature during short circuit: +250°C	
Lowest ambient temperature of mobile systems: -25°C	
Flame retardant: IEC 60332-1-2	
Oil resistance: IEC 60811	
Excellent flexibility	
Abrasion and tear resistant	
UV, ozone & oil resistant	
Application	Electrically driven machines, movable electric apparatus in hazardous areas, portable electric apparatus. Section feeders. Open cast mining, medium sized draglines, shovels and drills. Suitable for reeling purposes. Other industrial applications
Standard length cable packing	500 m on drums. Other forms of packing and delivery are available on request

Table 1

Physical properties	
Power cores	
Conductor sizes (mm ²)	120
Maximum wire diameter (mm)	0.51
Approximate conductor diameter (mm)	15.5
Maximum screen wire diameter (mm)	0.31
Braided screen filling factor (%)	60
Approximate summarized screen cross-section for power cores - weighting method (mm ²)	43
Pilot cores	
Conductor sizes (mm ²)	16
Maximum wire diameter (mm)	0.41
Approximate conductor diameter (mm)	5.3
ECC size (mm ²)	70
ECC maximum wire diameter (mm)	0.51
Cable info	
Lay Ratio (maximum) (x PCD)	20
Approximate cable diameter (mm)	72.5 *
Approx. cable mass. (kg/km)	
Type 611	8.23
Type 611 ECC	8.58
Minimum bending radius (mm)	640
Maximum recommended tension (kN)	5.4

Other sizes available upon request



Power
your mine
with us



VDE STANDARDS AND (HD) HARMONIZED STANDARDS

R-(N)TSCGEWÖU 3.6/6 to 18/30 kV	18
F-(N)TSCGEWÖU 3.6/6 to 18/30 kV	23
NTMCGCWÖU 3.6/6 to 18/30 kV	27
NSHTÖU-J 0.6/1 kV	29
NSSHÖU 0.6/1 kV with individual core screen	33
NSSHÖU 0.6/1 kV with individual core screen and pilot conductor	35
(N)TMCGETMPU 6/10 to 14/25 kV	37
(N)TMCETMPU 6/10 to 14/25 kV	39
(N)TMH3S 0.6/1 kV	41
(N)TSKCGEWÖU 3.6/6 (7.2) kV	43
NTSKCGWÖU 0.6/1 (1.2) kV	46
NTSKCGWÖU 0.6/1 (1.2) kV KON	48
RIT-(N)TMCGETMPU 6/10 to 14/25 kV	50
TRM-J 0.69/1.15 kV	52

R-(N)TSCGEWÖU 3.6/6 to 18/30 kV

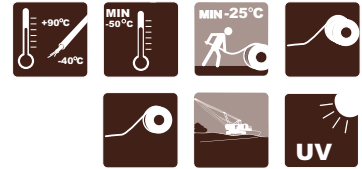

Medium voltage reeling cables	
Standards: DIN VDE 0250 p. 813	
CONSTRUCTION	
Conductors	Annealed flexible stranded tin coated or bare copper class 5 to IEC 60228, HD 383
Separator	If needed a suitable semi-conductive tape between the conductor and insulation
Conductor screen	Semi-conductive layer
Insulation	Ethylene-propylene rubber (EPR) type 3GI3 to DIN VDE 0207 part 20
Insulation screen	Semi-conductive layer max. resistivity of semi-conductive layers - 200 Ω x m
Internal layer of sheath	A synthetic thermosetting compound type 5GM3 in accordance to DIN VDE 0207 part 21
Antitorsion braid	Braid of polyamide threads between internal and outer layer of sheath
Outer layer of sheath	A synthetic thermosetting compound type 5GM5 or 5GM3 to DIN VDE 0207 part 21
Colour of outer jacket	Red or other colours can be provided
Standard marking	TF KABLE 3 R-(N)TSCGEWÖU (Size) (Voltage) (Year)
CHARACTERISTICS	
Excellent tear, impact and abrasion resistant	
Flame retardant	
Temperature range -25°C to +90°C. For fixed installation lowest temperature is -40°C	
UV, sunlight, ozone and oil resistant	
Embossing marking for easy identification	
Application	For connection of large material handling machines such as excavators, dumpers, crushers in open-cast mines Cables are suitable for high mechanical stresses in conjunction with mono spiral reels and cylindrical reels Other industrial applications
Standard length cable packing	500 m on drums. Other forms of packing and delivery are available on request

Number of cores Cross-section	Conductor diameter	Approximate overall diameter	Approximate weight	Conductor resistance at 20°C	Current-carrying capacity at 30°C
mm ²	mm	mm	kg/km	Ω/km	A
3.6/6 kV R-(N)TSCGEWÖU					
3x25+3x16/3	6.60	39.9	2414	0.795	132
3x25+3x25/3	6.60	39.9	2486	0.795	132
3x25+3x50/3	6.60	39.9	2666	0.795	132
3x35+3x25/3	7.30	41.5	2860	0.565	161
3x35+3x50/3	7.30	41.5	3042	0.565	161
3x50+3x25/3	9.30	45.8	3561	0.393	202
3x50+3x50/3	9.30	45.8	3747	0.393	202
3x70+3x35/3	11.10	49.1	4420	0.277	251
3x70+3x50/3	11.10	49.1	4688	0.277	251
3x95+3x50/3	13.30	56.2	5780	0.210	301
3x120+3x70/3	14.40	58.4	6800	0.164	351
3x150+3x70/3	16.30	64.5	8231	0.132	405
3x185+3x95/3	18.50	69.3	9711	0.108	462
3x240+3x120/3	19.80	72.6	11733	0.0817	540
6/10 kV R-(N)TSCGEWÖU					
3x25+3x25/3	6.60	41.6	2640	0.795	132
3x25+3x50/3	6.60	41.6	2821	0.795	132
3x35+3x25/3	7.30	43.2	3018	0.565	161
3x35+3x50/3	7.30	43.2	3200	0.565	161
3x50+3x25/3	9.30	47.5	3735	0.393	202
3x50+3x50/3	9.30	47.5	3922	0.393	202
3x70+3x35/3	11.10	52.6	4839	0.277	251
3x70+3x50/3	11.10	52.6	4943	0.277	251
3x95+3x50/3	13.30	58.0	5995	0.210	301
3x120+3x70/3	14.40	60.1	7023	0.164	351
3x150+3x70/3	16.30	66.2	8478	0.132	405
3x185+3x95/3	18.50	71.0	9975	0.108	462
3x240+3x120/3	19.80	76.1	12339	0.0817	540
3x300+3x150/3	23.80	84.1	15031	0.0654	620
8.7/15 kV R-(N)TSCGEWÖU					
3x25+3x25/3	6.60	45.1	2972	0.795	138
3x25+3x50/3	6.60	45.1	3153	0.795	138
3x35+3x25/3	7.30	46.7	3363	0.565	173
3x35+3x50/3	7.30	46.7	3544	0.565	173
3x50+3x25/3	9.30	52.8	4338	0.393	216
3x50+3x50/3	9.30	52.8	4525	0.393	216
3x70+3x35/3	11.10	56.0	5249	0.277	265
3x70+3x50/3	11.10	56.0	5359	0.277	265
3x95+3x50/3	13.30	63.2	6723	0.210	320
3x120+3x70/3	14.40	65.4	7777	0.164	370
3x150+3x70/3	16.30	69.7	8997	0.132	428
3x185+3x95/3	18.50	76.2	10860	0.108	489

Number of cores Cross-section	Conductor diameter	Approximate overall diameter	Approximate weight	Conductor resistance at 20°C	Current-carrying capacity at 30°C
mm ²	mm	mm	kg/km	Ω/km	A
3x240+3x120/3	19.80	79.6	12934	0.0817	574
12/20 kV R-(N)TSCGEWÖU					
3x25+3x25/3	6.60	48.1	3282	0.795	138
3x25+3x50/3	6.60	48.1	3469	0.795	138
3x35+3x25/3	7.30	51.5	3905	0.565	173
3x35+3x50/3	7.30	51.5	4091	0.565	173
3x50+3x25/3	9.30	55.8	4707	0.393	216
3x50+3x50/3	9.30	55.8	4888	0.393	216
3x70+3x35/3	11.10	59.0	5632	0.277	265
3x70+3x50/3	11.10	59.0	5743	0.277	265
3x95+3x50/3	13.30	66.2	7155	0.210	320
3x120+3x70/3	14.40	68.4	8230	0.164	370
3x150+3x70/3	16.30	72.7	9471	0.132	428
3x185+3x95/3	18.50	79.2	11377	0.108	489
3x240+3x120/3	19.80	82.6	13474	0.0817	574
18/30 kV R-(N)TSCGEWÖU					
3x25+3x25/3	6.60	57.6	3945	0.795	138
3x25+3x50/3	6.60	57.6	4125	0.795	138
3x35+3x25/3	7.30	59.3	4367	0.565	173
3x35+3x50/3	7.30	59.3	4554	0.565	173
3x50+3x25/3	9.30	65.4	5199	0.393	216
3x50+3x50/3	9.30	65.4	5386	0.393	216
3x70+3x35/3	11.10	68.6	6437	0.277	265
3x70+3x50/3	11.10	68.6	6547	0.277	265
3x95+3x50/3	13.30	75.8	7744	0.210	320
3x120+3x70/3	14.40	77.9	8897	0.164	370
3x150+3x70/3	16.30	82.3	10453	0.132	428
3x185+3x95/3	18.50	88.8	12078	0.108	489
3x240+3x120/3	19.80	92.1	14584	0.0817	574

PHYSICAL PARAMETERS	
Insulation	
Tensile tests for insulation shall value as follows:	
Un aged test pieces	Tensile strength min. 6 N/mm ²
	Elongation at break min. 200%
Ageing in air oven	135°C, 168 h
	Change TS +/- 30%
	Change EB +/- 30%
Internal sheath	
Tensile tests shall value as follows:	
Un aged test pieces	Tensile strength min. 10 N/mm ²
	Elongation at break min. 300%
Ageing in air oven	100°C, 168 h
	Change TS +/- 30%, EB +/- 40%
After ageing in oil	100°C, 24 h
	Change TS and EB +/- 40%
Outer sheath	
Tensile tests shall value as follows:	
Un aged test pieces	Tensile strength min. 15 N/mm ²
	Elongation at break min. 300%
Ageing in air oven	100°C, 168 h
	Change TS +/- 30%, EB +/- 40%
After ageing in oil	100°C, 24 h
	Change TS and EB +/- 40%
Tear resistance	Value of min. 30 N/mm

ELECTRICAL PARAMETERS							
Current-carrying capacity: according to DIN VDE 0298 part 4							
Conversion factor for current rating ambient temperatures deviating from 30°C							
Ambient temp. °C	20	25	30	35	40	45	50
Conversion factor	1.09	1.05	1.0	0.92	0.88	0.83	0.78
Voltage tests	Cables shall be tested in air and withstand voltage test applied: between power, earth conductors and screen in accordance to DIN VDE 0250 part 813						
Partial discharge	max. 40 pC acc. to DIN VDE 0250 p. 813. Our cables exceed required parameters						

THERMAL PARAMETERS	
Ambient temperature	for fixed installation +80°C/-40°C
	for mobile application +60°C/-25°C
Maximum permissible operating temperature of conductor	90°C
Short-circuit temperature of conductor	250°C

MECHANICAL PARAMETERS

Smallest admissible bending radius	according to DIN VDE 0298 part 3
The manufacturer recommended as below:	
for fixed installation 6 D, D - cable diameter	
for forced guidance with reeling operations 12 D	
for forced guidance with sheaves 15 D	
Torsion stress +/- 100 ⁰ /m	
Tensile load up to 20N/mm ²	

CHEMICAL PARAMETERS

Resistance to oil	DIN VDE, part 811-2-1 p. 10
Weather resistance	resistant to ozone, UV and moisture

F-(N)TSCGEWÖU 3.6/6 to 18/30 kV



Medium voltage cables for fixed applications	
Standards: DIN VDE 0250 p. 813	
CONSTRUCTION	
Conductors	Annealed flexible stranded tin coated or bare copper class 5 to IEC 60228, HD 383
Separator	If needed a suitable semi-conductive tape between the conductor and insulation
Conductor screen	Semi-conductive layer
Insulation	High grade EPR thermosetting compound exceed parameters type 3GI3 to DIN VDE 0207 part 20
Insulation screen	Semi-conductive layer max. resistivity of semi-conductive layers $-200 \Omega \times m$
Internal layer of sheath	A synthetic thermosetting compound
Outer layer of sheath	A synthetic thermosetting compound type 5GM5 or 5GM3 to DIN VDE 0207 part 21
Colour of outer jacket	Red or other colours can be provided
Standard marking	TF KABLE 3 F-(N)TSCGEWÖU (Size) (Voltage) (Year)
CHARACTERISTICS	
Excellent tear, impact and abrasion resistant	
Flame retardant	
Temperature range -25°C to +90°C. For fixed installation lowest temperature is -40°C	
UV, sunlight, ozone and oil resistant	
Embossing marking for easy identification	
Application	For laying alongside the conveyor belts and on material handling equipment and for connection of submersible pump units Other industrial applications
Standard length cable packing	500 m on drums. Other forms of packing and delivery are available on request

Number of cores Cross-section	Conductor diameter	Approximate overall diameter	Approximate weight	Conductor resistance at 20°C	Current-carrying capacity at 30°C
mm ²	mm	mm	kg/km	Ω/km	A
3.6/6 kV F-(N)TSCGEWÖU					
3x25+3x25/3	6.30	40.3	2492	0.795	132
3x25+3x50/3	6.30	40.3	2613	0.795	132
3x35+3x25/3	7.00	41.8	2858	0.565	161
3x35+3x50/3	7.00	41.8	2979	0.565	161
3x50+3x25/3	9.00	46.2	3557	0.393	202
3x50+3x50/3	9.00	46.2	3677	0.393	202
3x70+3x35/3	10.80	51.8	4593	0.277	251
3x70+3x50/3	10.80	51.8	4714	0.277	251
3x95+3x50/3	12.90	56.4	5665	0.210	301
3x120+3x70/3	14.00	58.7	6718	0.164	351
3x150+3x70/3	15.80	64.0	7968	0.132	405
3x185+3x95/3	18.10	68.0	9415	0.108	462
3x240+3x120/3	19.60	72.0	11395	0.0817	540
3x300+3x150/3	23.20	82.2	14350	0.0654	620
6/10 kV F-(N)TSCGEWÖU					
3x25+3x25/3	6.30	42.0	2649	0.795	132
3x25+3x50/3	6.30	42.0	2769	0.795	132
3x35+3x25/3	7.00	43.6	3021	0.565	161
3x35+3x50/3	7.00	43.6	3141	0.565	161
3x50+3x25/3	9.00	47.9	3735	0.393	202
3x50+3x50/3	9.00	47.9	3856	0.393	202
3x70+3x35/3	10.80	53.6	4794	0.277	251
3x70+3x50/3	10.80	53.6	4914	0.277	251
3x95+3x50/3	12.90	58.1	5882	0.210	301
3x120+3x70/3	14.00	60.4	6944	0.164	351
3x150+3x70/3	15.80	66.2	8342	0.132	405
3x185+3x95/3	18.10	71.0	9873	0.108	462
3x240+3x120/3	19.60	76.0	11989	0.0817	540
3x300+3x150/3	23.20	83.9	14665	0.0654	620
8.7/15 kV F-(N)TSCGEWÖU					
3x25+3x25/3	6.30	45.4	2981	0.795	138
3x25+3x50/3	6.30	45.4	3101	0.795	138
3x35+3x25/3	7.00	47.0	3365	0.565	173
3x35+3x50/3	7.00	47.0	3485	0.565	173
3x50+3x25/3	9.00	53.1	4330	0.393	216
3x50+3x50/3	9.00	53.1	4450	0.393	216
3x70+3x35/3	10.80	57.0	5214	0.277	265
3x70+3x50/3	10.80	57.0	5335	0.277	265
3x95+3x50/3	12.90	63.3	6597	0.210	320
3x120+3x70/3	14.00	67.1	7919	0.164	370
3x150+3x70/3	15.80	69.7	8859	0.132	428
3x185+3x95/3	18.10	76.2	10740	0.108	489

Number of cores Cross-section	Conductor diameter	Approximate overall diameter	Approximate weight	Conductor resistance at 20°C	Current-carrying capacity at 30°C
mm ²	mm	mm	kg/km	Ω/km	A
3x240+3x120/3	19.60	79.5	12581	0.0817	574
3x300+3x150/3	23.20	89.2	15684	0.0654	665
12/20 kV F-(N)TSCGEWÖU					
3x25+3x25/3	6.30	48.5	3294	0.795	138
3x25+3x50/3	6.30	48.5	3414	0.795	138
3x35+3x25/3	7.00	51.8	3900	0.565	173
3x35+3x50/3	7.00	51.8	4021	0.565	173
3x50+3x25/3	9.00	56.1	4693	0.393	216
3x50+3x50/3	9.00	56.1	4814	0.393	216
3x70+3x35/3	10.80	60.0	5604	0.277	265
3x70+3x50/3	10.80	60.0	5724	0.277	265
3x95+3x50/3	12.90	66.3	7029	0.210	320
3x120+3x70/3	14.00	70.1	8377	0.164	370
3x150+3x70/3	15.80	72.7	9332	0.132	428
3x185+3x95/3	18.10	79.3	11258	0.108	489
3x240+3x120/3	19.60	82.5	13120	0.0817	574
3x300+3x150/3	23.20	92.2	16288	0.0654	665
18/30 kV F-(N)TSCGEWÖU					
3x25+3x25/3	6.30	58.0	4426	0.795	138
3x25+3x50/3	6.30	58.0	4546	0.795	138
3x35+3x25/3	7.00	59.6	4853	0.565	173
3x35+3x50/3	7.00	59.6	4974	0.565	173
3x50+3x25/3	9.00	65.7	5990	0.393	216
3x50+3x50/3	9.00	65.7	6110	0.393	216
3x70+3x35/3	10.80	69.6	6982	0.277	265
3x70+3x50/3	10.80	69.6	7103	0.277	265
3x95+3x50/6	12.90	75.9	8543	0.210	320
3x120+3x70/3	14.00	78.2	9695	0.164	370
3x150+3x70/3	15.80	82.2	10981	0.132	428
3x185+3x95/3	18.10	88.8	13046	0.108	489
3x240+3x120/3	19.60	92.0	14977	0.0817	574

PHYSICAL PARAMETERS	
Insulation	
Tensile tests for insulation shall value as follows:	
Un aged test pieces	Tensile strength min. 6 N/mm ²
	Elongation at break min. 200%
Ageing in air oven	135°C, 168 h
	Change TS +/- 30%
	Change EB +/- 30%
Outer sheath	
Tensile tests shall value as follows:	
Un aged test pieces	Tensile strength min. 15 N/mm ²
	Elongation at break min. 300%
Ageing in air oven	100°C, 168 h
	Change TS +/- 30%, EB +/- 40%
After ageing in oil	24°C, 168 h
	Change TS and EB +/- 40%
Tear resistance	Value of min. 30 N/mm

ELECTRICAL PARAMETERS							
Current-carrying capacity: according to DIN VDE 0298 part 4							
Conversion factor for current rating ambient temperatures deviating from 30°C							
Ambient temp. °C	20	25	30	35	40	45	50
Conversion factor	1.09	1.05	1.0	0.92	0.88	0.83	0.78
Voltage tests	Cables shall be tested in air and withstand voltage test applied: between power, earth conductors and screen in accordance to DIN VDE 0250 part 813						
Partial discharge	max. 40 pC acc. to DIN VDE 0250 p. 813. Our cables exceed required parameters						

THERMAL PARAMETERS	
Ambient temperature	for fixed installation +90°C/-40°C
Maximum permissible operating temperature of conductor	90°C
Short-circuit temperature of conductor	250°C

MECHANICAL PARAMETERS	
Smallest admissible bending radius	according to DIN VDE 0298 part 3
The manufacturer recommended as below:	
for fixed installation 6 D, D - cable diameter	
Tensile load up to 20N/mm ²	

CHEMICAL PARAMETERS	
Resistance to oil	DIN VDE, part 811-2-1 p. 10
Weather resistance	resistant to ozone, UV and moisture

NTMCGCWÖU 3.6/6 to 18/30 kV

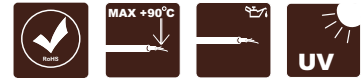

Medium voltage flexible single core cables	
Standards: DIN VDE 0250 p. 813	
CONSTRUCTION	
Conductors	Annealed flexible stranded tin coated class 5 to IEC 60228, HD 383
Conductor screen	Semi-conductive tape + layer between the conductor and insulation
Insulation	Ethylene-propylene rubber (EPR) type 3GI3 in accordance to DIN VDE 0207 p. 20
Insulation screen	Semi-conductive layer over insulation + the warp or braid of tinned copper wires
Separator	The wrap of synthetic tape
Outer jacket	A synthetic thermosetting compound type 5GM3 in accordance to DIN VDE 0207 p. 21
Colour of outer jacket	Red or other colours can be provided
Standard marking	TF KABLE 3 (N)TMCGCWÖU (Size) (Voltage) (Year)
CHARACTERISTICS	
Medium voltage cables with concentric screen	
Moisture resistant and flame retardant	
Temperature range for mobile installation -25°C to +60°C. For fixed installation -40°C to +80°C.	
UV, sunlight, ozone and oil resistant	
Ink jet printed for easy identification	
Application	For connection of switchgear cubicles mobile transformers substations to the overhead lines Other industrial applications
Standard length cable packing	1000 m on drums. Other forms of packing and delivery are available on request

Size	Nominal insulation thickness	Nominal jacket thickness	Approximate overall diameter	Approximate weight	Current rating at 30°C in air
mm ²	mm	mm	mm	kg/km	A
NTMCGEWÖU 3.6/6 kV					
1x16/16	3.4	2.20	20.3	720	141
1x25/16	3.4	2.20	21.5	828	187
1x35/16	3.4	2.20	22.2	933	231
1x50/16	3.4	2.20	24.2	1119	288
1x70/16	3.4	2.50	26.6	1384	357
1x95/16	3.4	2.50	28.7	1637	430
1x120/16	3.4	2.50	29.8	1888	503
1x150/25	3.4	3.00	32.7	2382	577
1x185/25	3.4	3.00	34.9	2725	658
NTMCGEWÖU 6/10 kV					
1x16/16	3.4	2.2	21.1	755	141
1x25/16	3.4	2.2	22.3	864	187
1x35/16	3.4	2.2	23.0	970	231
1x50/16	3.4	2.5	25.6	1197	289
1x70/16	3.4	2.5	27.4	1429	356
1x95/16	3.4	2.5	29.5	1686	430
1x120/16	3.4	3.0	31.6	2016	503
1x150/25	3.4	3.0	33.5	2438	577
1x185/25	3.4	3.5	35.7	2785	658
NTMCGEWÖU 12/20 kV					
1x16/16	5.5	2.50	25.9	994	150
1x25/16	5.5	2.50	27.1	1116	198
1x35/16	5.5	2.50	27.8	1230	245
1x50/16	5.5	2.50	29.8	1440	307
1x70/16	5.5	3.00	32.6	1767	379
1x95/16	5.5	3.00	34.7	2048	456
1x120/16	5.5	3.00	35.8	2312	531
1x150/25	5.5	3.50	38.7	2846	611
1x185/25	5.5	3.50	40.9	3218	698
NTMCGEWÖU 18/30 kV					
1x16/16	8.0	3.00	31.9	1368	150
1x25/16	8.0	3.00	33.1	1505	198
1x35/16	8.0	3.00	33.8	1629	245
1x50/16	8.0	3.00	35.8	1866	307
1x70/16	8.0	3.50	38.6	2230	379
1x95/16	8.0	3.50	40.7	2539	456
1x120/16	8.0	3.50	41.8	2818	531
1x150/25	8.0	3.50	43.7	3284	611
1x185/25	8.0	3.50	45.9	3680	698

NSHTÖU-J 0.6/1 kV

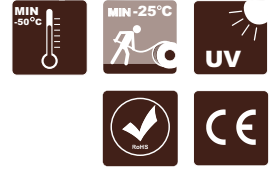

Rubber insulated flexible cables for Hoisting and Hauling Equipment	
Standards: DIN VDE 0250 p. 814	
CONSTRUCTION	
Conductors	Annealed flexible stranded tin coated class 5 to IEC 60228, HD 383
Separator	If needed a suitable tape separator between the conductor and insulation
Insulation	Ethylene-propylene rubber (EPR) type 3GI3 to DIN VDE 0207 p. 20
Circuit identification	Colour coding of power conductors comply to HD 308, DIN VDE 0293-308
3-core	Green-yellow, blue, brown
4-core	Green-yellow, brown, black, grey
5-core	Green-yellow, blue, brown black, grey
Above 5-core	Green-yellow, other cores black with white numbering
Internal jacket	A synthetic thermosetting compound
Reinforcing braid	An open polyamide braid
Outer jacket	A synthetic thermosetting compound type 5GM3 to DIN VDE 0207 p. 21
Colour of outer jacket	Black or other colours can be provided
Flame propagation	IEC 60332-1-2:2004, EN 60332-1-2:2004
Standard marking	TF KABLE 3 CE NSHTÖU-J (Size) (Year)
CHARACTERISTICS	
Tear, abrasion and impact resistant jacket	
Water resistant and flame retardant	
Temperature range -25°C to +60°C. For fixed installation lowest temperature is -40°C	
UV, sunlight, ozone and oil resistant	
Ink jet printed for easy identification	
Application	Cables are used for high mechanical stress, especially for applications with frequent winding and unwinding with simultaneous tensile and torsion stress, for building machinery, conveyors, shifts and cranes. The cables are suitable for outdoor installation in dry, damp and wet places Other industrial applications
Standard length cable packing	1000 m on drums. Other forms of packing and delivery are available on request

Number and cross-sectional area of conductor	Maximum diameter of wires in conductor	Nominal thickness of insulation	Nominal thickness of sheath		Approximate overall diameter	Approximate net weight of cables	Maximum conductor resistance at 20°C
			Inner	Outer			
n x mm ²	mm	mm	mm		mm	kg/km	Ω/km
3x1.5	0.26	0.8	1.0	1.6	11.9	204	13.7
3x2.5	0.26	0.9	1.0	1.6	13.3	268	8.21
3x4	0.31	1.0	1.2	2.0	17.4	392	5.09
3x6	0.31	1.0	1.2	2.0	18.6	478	3.39
3x10	0.41	1.2	1.4	2.2	22.5	727	1.95
3x16	0.41	1.2	1.4	2.2	25.0	961	1.24
3x25	0.41	1.4	1.6	2.5	29.4	1391	0.795
3x35	0.41	1.4	1.8	3.0	32.3	1820	0.565
3x50	0.41	1.6	2.0	3.5	38.9	2596	0.393
3x70	0.51	1.6	2.0	3.5	42.8	3335	0.277
3x95	0.51	1.8	2.4	4.0	50.0	4458	0.210
3x120	0.51	1.8	2.4	4.0	52.3	5272	0.164
3x150	0.51	2.0	2.4	4.0	57.2	6401	0.132
3x240	0.51	2.4	3.2	5.0	69.0	10554	0.0817
4x1.5	0.26	0.8	1.0	1.6	12.7	238	13.7
4x2.5	0.26	0.9	1.2	2.0	15.5	360	8.21
4x4	0.31	1.0	1.2	2.0	18.5	463	5.09
4x6	0.31	1.0	1.2	2.0	19.9	571	3.39
4x10	0.41	1.2	1.4	2.2	24.2	878	1.95
4x16	0.41	1.2	1.6	2.5	26.7	1212	1.24
4x25	0.41	1.4	1.8	3.0	32.1	1821	0.795
4x35	0.41	1.4	1.8	3.0	33.8	2380	0.565
4x50	0.41	1.6	2.0	3.5	41.0	3368	0.393
4x70	0.51	1.6	2.0	3.5	46.0	4367	0.277
4x95	0.51	1.8	2.4	4.0	54.3	5562	0.210
4x120	0.51	1.8	2.8	4.5	57.3	6873	0.164
4x150	0.51	2.0	2.8	4.5	64.2	8350	0.132
5x1.5	0.26	0.8	1.0	1.6	13.6	269	13.7
5x2.5	0.26	0.9	1.2	2.0	16.6	421	8.21
5x6	0.31	1.0	1.4	2.2	21.4	764	3.39
5x10	0.41	1.2	1.4	2.2	25.0	1072	1.95
5x16	0.41	1.2	1.6	2.5	29.0	1533	1.24
7x1.5	0.26	0.8	1.2	2.0	16.9	415	13.7
7x2.5	0.26	0.9	1.2	2.0	19.1	556	8.21
7x4	0.31	1.0	1.4	2.2	22.7	796	5.09
10x4	0.31	1.0	1.4	2.2	26.0	1007	5.09
12x1.5	0.26	0.8	1.4	2.2	20.3	599	13.7

Number and cross-sectional area of conductor	Maximum diameter of wires in conductor	Nominal thickness of insulation	Nominal thickness of sheath		Approximate overall diameter	Approximate net weight of cables	Maximum conductor resistance at 20°C
			Inner	Outer			
n x mm ²	mm	mm	mm		mm	kg/km	Ω/km
12x2.5	0.26	0.9	1.4	2.2	23.1	813	8.21
18x1.5	0.26	0.8	1.4	2.2	22.9	789	13.7
18x2.5	0.26	0.9	1.6	2.5	27.3	1156	8.21
18x4	0.31	1.0	1.8	3.0	43.4	1837	5.09
24x1.5	0.26	0.8	1.4	2.2	26.0	985	13.7
24x2.5	0.26	0.9	1.4	2.2	31.1	1454	8.21
36x1.5	0.26	0.8	1.6	2.5	30.0	1297	13.7
36x2.5	0.26	0.9	1.8	3.0	36.3	2075	8.21
37x1.5	0.26	0.8	1.6	2.5	31.0	1343	13.7
3x2.5+1.5	0.26/0.26	0.9/0.8	1.2	2.0	16.5	346	8.21/13.7
3x4+2.5	0.31/0.26	1.0/0.9	1.2	2.0	18.1	439	5.09/8.21
3x6+2.5	0.31/0.26	1.0/0.9	1.2	2.0	19.2	520	3.39/8.21
3x6+4	0.31/0.31	1.0/1.0	1.2	2.0	19.6	544	3.39/5.09
3x16+10	0.41/0.41	1.2/1.2	1.6	2.5	27.3	1164	1.24/1.95
3x25+16	0.41/0.41	1.4/1.2	1.8	3.0	32.2	1698	0.795/1.24
3x35+16	0.41/0.41	1.4/1.2	1.8	3.0	33.5	2021	0.565/1.24
3x70+35	0.51/0.41	1.6/1.4	2.0	3.9	46.0	4123	0.277/0.565
3x95+50	0.51/0.41	1.8/3.8	2.4	4.0	53.0	5515	0.210/0.393
3x150+3x70/3	0.51/0.41	2.0/1.4	2.4	4.0	56.1	7195	0.132/0.277
3x185+3x95	0.51/0.41	2.2/1.4	2.8	4.5	63.4	9150	0.108/0.210
3x240+3x95/3	0.51/0.41	2.2/1.4	3.2	5.0	69.1	11290	0.0817/0.210
3x240+3x120/3	0.51/0.41	2.2/1.4	3.2	5.0	69.1	11290	0.0817/0.164

Current rating

Number of loaded cores	2 or 3 ^{*,**}
Conductor cross-section in mm ²	Current rating, A
1.5	18
2.5	26
4	34
6	44
10	61
16	82
25	108
35	135
50	168
70	207
95	250
120	292
150	335
185	378

Current rating as defined to DIN VDE 0298-4. Ambient air temperature: 30°C. Operating temperature at conductor 60°C.

* Correction factors for the above given current ratings other ambient temperatures than 30°C

Temperature, °C	30	35	40	45	50	55
Correction factors	1.00	0.91	0.82	0.71	0.58	0.41

** Conversion factors for multi-core cable (≥ 5 cores) for cross-section to 10 mm²

Number of loaded cores	Correction factors
5	0.75
7	0.65
10	0.55
14	0.50
19	0.45
24	0.40

NSSHÖU 0.6/1 kV with individual core screen



Heavy duty tough rubber sheathed flexible cables for mines and industry	
CONSTRUCTION	
Conductors	Annealed flexible stranded tin coated or bare copper class 5 to IEC 60228, HD 383
Separator	A suitable tape separator between the conductor and insulation
Insulation	Ethylene-propylene rubber (EPR) type 3GI3 in accordance to DIN VDE 0207 p. 21
Circuit identification	Brown, black, grey
Internal jacket	A synthetic thermosetting compound type GM1b in accordance to DIN VDE 0207 p. 21
Outer jacket	A synthetic thermosetting compound type 5GM3 to DIN VDE 0207 p. 21
Colour of outer jacket	Yellow
CHARACTERISTICS	
High resistance to ripping and notching, to abrasion, oils, greases, chemicals and weather influences, flame resistant, good flexibility even at low ambient temperatures	
Temperature range -25°C to +90°C. For fixed installation lowest temperature is -40°C	
UV, sunlight, ozone and oil resistant	
Ink jet or embossing printed for easy identification	
Application	For use in mines, quarries and industrial areas, indoors and outdoors, for higher mechanical stresses as flexible cable and as trailing cable for mobile current consumers. Other industrial applications where individual copper screen power cores is needed
Standard length cable packing	1000 m on drums. Other forms of packing and delivery are available on request

Number and cross-sectional area of conductor	Maximum diameter of wires in conductor	Nominal thickness of insulation	Nominal thickness of inner sheath	Nominal thickness of outer sheath	Approximate overall diameter	Approximate net weight of cables	Maximum conductor resistance at 20°C
n x mm ²	mm	mm	mm	mm	mm	kg/km	Ω/km
3x1.5+3x1.5/3E	0.25	0.8	1.0	1.6	13.9	286	13.7
3x2.5+3x2.5/3E	0.25	0.9	1.2	2.0	16.6	403	8.21
3x4+3x4/3E	0.3	1.0	1.2	2.0	18.4	519	5.09
3x6+3x6/3E	0.3	1.0	1.2	2.0	19.7	611	3.39
3x10+3x10/3E	0.4	1.2	1.4	2.2	23.3	882	1.95
3x16+3x10/3E	0.4	1.2	1.4	2.2	27.1	1256	1.24
3x16+3x16/3E	0.4	1.2	1.4	2.2	27.1	1315	1.24
3x25+3x16/3E	0.4	1.4	1.6	2.5	31.4	1754	0.795
3x35+3x16/3E	0.4	1.4	1.8	3.0	33.7	2115	0.565
3x50+3x25/3E	0.4	1.6	2.0	3.5	41.4	3147	0.393
3x50+3x35/3E	0.4	1.6	2.0	3.5	41.8	3342	0.393
3x70+3x35/3E	0.4	1.6	2.0	3.5	45.1	3989	0.277
3x95+3x35/3E	0.4	1.8	2.4	4.0	50.9	4496	0.210
3x95+3x50/3E	0.4	1.8	2.4	4.0	50.9	4564	0.210
3x120+3x70/3E	0.4	1.8	2.4	4.0	55.1	6543	0.164
3x150+3x70/3E	0.4	2.0	2.4	4.0	60.0	7728	0.132
3x185+3x95/3E	0.4	2.2	2.8	4.5	67.4	9603	0.108
3x240+3x70/3E*	0.4	2.4	2.8	4.5	71.5	11211	0.0817

* based on standard

The tabulated ratings are for cables run in free air. Ambient air temperature: 30°C. Temperature at conductor 90°C

Conductor cross-section	Current ratings	Conductor cross-section	Current ratings
mm ²	A	mm ²	A
1.5	-	35	162
2.5	30	50	202
4	41	70	250
6	53	95	301
10	74	120	352
16	99	150	404
25	131	185	461

* Correction factors for the above given current ratings other ambient temperatures than 30°C

Temperature, °C	10	15	20	25	30	35	40	45	50	55	60	65	70	75
Correction factors	1.15	1.12	1.08	1.04	1.00	0.95	0.89	0.84	0.77	0.71	0.63	0.55	0.45	0.32

NSSHÖU 0.6/1 kV with individual core screen and pilot conductor



Heavy duty tough rubber sheathed flexible cables for mines and industry	
Standards: DIN VDE 0250 p. 812	
CONSTRUCTION	
Conductors	Annealed flexible stranded tin coated or bare copper class 5 to IEC 60228, HD 383
Separator	A suitable tape separator between the conductor and insulation
Insulation	Ethylene-propylene rubber (EPR) type 3GI3 in accordance to DIN VDE 0207 p. 21
Circuit identification	Brown, black, grey + interstitial three insulated pilot cores
Internal jacket	A synthetic thermosetting compound type GM1b in accordance to DIN VDE 0207 p. 21
Outer jacket	A synthetic thermosetting compound type 5GM3 in accordance to DIN VDE 0207 p. 21
Colour of outer jacket	Yellow
CHARACTERISTICS	
High resistance to ripping and notching, to abrasion, oils, greases, chemicals and weather influences, flame resistant, good flexibility even at low ambient temperatures	
Temperature range -25°C to +90°C. For fixed installation lowest temperature is -40°C	
UV, sunlight, ozone and oil resistant	
Ink jet or embossing printed for easy identification	
Application	For use in mines, quarries and industrial areas, indoors and outdoors, for higher mechanical stresses as flexible cable and as trailing cable for mobile current consumers. Other industrial applications where individual copper screen power cores is needed
Standard length cable packing	1000 m on drums. Other forms of packing and delivery are available on request

Number and cross-sectional area of conductor	Maximum diameter of wires in conductor	Nominal thickness of insulation	Nominal thickness of inner sheath	Nominal thickness of outer sheath	Approximate overall diameter	Approximate net weight of cables	Maximum conductor resistance at 20°C
n x mm ²	mm	mm	mm	mm	mm	kg/km	Ω/km
3x2.5+3x2.5/3E+3x1.5ST	0.25	0.9	1.2	2.0	18.3	523	8.21
3x4+3x4/3E+3x1.5ST	0.3	1.0	1.2	2.0	18.4	547	5.09
3x6+3x6/3E+3x1.5ST	0.3	1.0	1.2	2.0	19.7	672	3.39
3x10+3x10/3E+3x2.5ST	0.4	1.2	1.4	2.2	23.3	928	1.95
3x16+3x16/3E+3x2.5ST	0.4	1.2	1.4	2.2	26.2	1286	1.24
3x25+3x16/3E+3x2.5ST	0.4	1.4	1.6	2.5	29.7	1707	0.795
3x35+3x16/3E+3x2.5ST	0.4	1.4	1.8	3.0	33.0	2116	0.565
3x50+3x25/3E+3x2.5ST	0.4	1.6	2.0	3.5	41.4	3058	0.393
3x70+3x35/3E+3x2.5ST	0.4	1.6	2.0	3.5	43.9	4504	0.277
3x95+3x50/3E+3x2.5ST	0.4	1.8	2.0	3.5	50.9	5243	0.210
3x120+3x70/3E+3x2.5	0.4	1.8	2.4	4.0	50.6	5318	0.164
3x150+3x70/3E+3x2.5	0.4	2.0	2.4	4.0	60.8	7916	0.132
3x185+3x95/3E+3x2.5	0.4	2.2	2.8	4.5	62.9	8150	0.108

The tabulated ratings are for cables run in free air. Ambient air temperature: 30°C. Temperature at conductor 90°C

Conductor cross-section	Current ratings	Conductor cross-section	Current ratings
mm ²	A	mm ²	A
1.5	-	35	162
2.5	30	50	202
4	41	70	250
6	53	95	301
10	74	120	352
16	99	150	404
25	131	185	461

* Correction factors for the above given current ratings other ambient temperatures than 30°C

Temperature, °C	10	15	20	25	30	35	40	45	50	55	60	65	70	75
Correction factors	1.15	1.12	1.08	1.04	1.00	0.95	0.89	0.84	0.77	0.71	0.63	0.55	0.45	0.32

(N)TMCGETMPU 6/10 kV to 14/25 kV

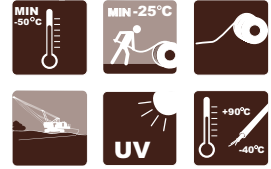

Three conductor round portable trailing cable	
Standards: Based on IEC 60502, VDE 0250 part 813, IEC 60228	
CONSTRUCTION	
Conductors	Finely stranded tinned copper, flexible, class 5 in accordance with IEC 60228
Conductor shield	Semi-conducting layer over the conductor
Insulation	Special thermosetting Ethylene-Propylene Rubber (EPR). High electrical, mechanical and temperature properties; quality better than type 3GI3 according to DIN VDE 0207, Part 20
Insulation shield	Semi-conducting strippable layer
Ground check conductor	Annealed tin coated copper in accordance with IEC 60228. Polypropylene insulation, yellow color
Grounding conductor (Earth)	Tinned copper conductor, flexible, finely stranded
Assembly	Three power, ground check and two grounding conductors cabled together. Semi-conducting binder tape applied overall. Integral filled jacket for higher torsion resistance
Jacket	Thermoplastic Polyurethane (TPU) compound, for extra heavy usage, oil resistant, very highly abrasion and very highly tear resistant
Colour of jacket	Yellow. Other colours can be provided
CHARACTERISTICS	
Excellent flexibility	
Highly ozone and weather resistant	
Excellent impact and abrasion resistant	
Oil and heat resistant	
Maximum conductor operating temperature: 90°C	
Maximum short-circuit current temperature: 200°C	
Rated and flexible at -30°C	
Voltage test: AC 17 kV for 6/10 kV, AC 24 kV for 8.7/15 kV, AC 36 for 14/25 kV. Time 5 min	
Minimum bending radius: ≥ 4 D fixed installation, ≥ 7.5 D free bending (on drum)	
Ink jet printed for easy identification	
Application	In surface and underground mines, quarries and industrial areas for connection of heavy mobile equipment such as shovels, drag lines, continuous miners, cutting and loading machines, dredges, drills, and other track equipment. For operation in extreme conditions where high mechanical stress is involved, in particular high tensile and abrasion stress. For operation in continuous reeling/unreeling applications where heavy mobile equipment is supplied with electrical power by using cable reels
Standard length cable packing	500 m on drums. Other forms of packing and delivery are available on request
Approvals	MSHA:P-07-KA120001-1-MSHA

Number and cross-section of power + grounding conductors	Power conductor stranding	Grounding/Ground check conductor stranding	Nominal insulation thickness	Nominal jacket thickness	Approximate overall diameter	Maximum conductor resistance at 20°C	Ampacity at ambient temperature 30°C	Approximate weight of cable
mm ²	N x mm	N x mm	mm	mm	mm	Ω/km	A	kg/km
6/10 kV								
3x70+2x35+1x35	514x0.4	254x0.4/254x0.4	3.4	5.5	54.3	0.277	250	5334
3x95+2x35+1x35	684x0.4	254x0.4/254x0.4	3.4	5.5	62.1	0.210	301	6701
3x120+2x50+1x35	870x0.4	364x0.4/254x0.4	3.4	5.5	65.8	0.164	352	7267
3x185+2x70+1x35	1325x0.4	514x0.4/254x0.4	3.4	5.5	75.1	0.108	461	10900
8.7/15 kV								
3x70+2x35+1x35	514x0.4	254x0.4/254x0.4	4.5	5.5	62.7	0.277	265	5900
3x95+2x35+1x35	684x0.4	254x0.4/254x0.4	4.5	5.5	67.7	0.210	319	6900
3x120+2x50+1x35	870x0.4	364x0.4/254x0.4	4.5	5.5	71.7	0.164	371	8200
3x185+2x70+1x35	1325x0.4	514x0.4/254x0.4	4.5	5.5	76.2	0.108	488	11900
14/25 kV								
3x70+2x35+1x35	514x0.4	254x0.4/254x0.4	6.8	5.5	69.2	0.277	265	7800
3x95+2x35+1x35	684x0.4	254x0.4/254x0.4	6.8	5.5	74.8	0.210	319	8800
3x120+2x50+1x35	870x0.4	364x0.4/254x0.4	6.8	5.5	77.8	0.164	371	9200
3x185+2x70+1x35	1325x0.4	514x0.4/254x0.4	6.8	5.5	85.8	0.108	488	13800

(N)TMCETMPU 6/10 kV to 14/25 kV

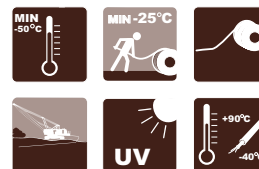

Three conductor round portable trailing cable	
Standards: Based on IEC 60502, VDE 0250 part 813, IEC 60228	
CONSTRUCTION	
Conductors	Finely stranded tinned copper, flexible, class 5 in accordance with IEC 60228
Power cores	Inner semi-conductive layer of rubber, insulation of dielectric and thermal high quality, ozone resistant, ethylene - propylene - rubber (EPR), outer semi-conductive layer of rubber. Conductive layers and insulation are applied and cross - linked in one process (triple extrusion). If needed Semi-Conductive tape separator. Mixed braid with tinned copper wires and colored textile threads
Insulation	Special thermosetting Ethylene-Propylene Rubber (EPR). High electrical, mechanical and temperature properties; quality better than type 3G13 according to DIN VDE 0207, Part 20
Circuit identification	Colored textile threads of braid: black, white, red
Ground check conductor	Annealed tin coated copper in accordance with IEC 60228. Polypropylene insulation , yellow color
Grounding conductor (Earth)	Tinned copper conductor, flexible, finely stranded
Assembly	Three power, and two earth and one ground check cabled together. Single faced rubber filled binder tape applied overall. Integral filled jacket for higher torsion resistance
Jacket	Thermoplastic Polyurethane (TPU) compound, for extra heavy usage, oil resistant, very highly abrasion and very highly tear resistant
Colour of jacket	Yellow. Other colours can be provided
CHARACTERISTICS	
Excellent flexibility	
Highly ozone and weather resistant	
Excellent impact and abrasion resistant	
Oil and heat resistant	
Maximum conductor operating temperature: 90°C	
Maximum short-circuit current temperature: 200°C	
Rated and flexible at -30°C	
Voltage test: AC 17 kV for 6/10 kV, AC 24 kV for 8.7/15 kV, AC 36 for 14/25 kV. Time 5 min	
Minimum bending radius: ≥ 4 D fixed installation, ≥ 7.5 D free bending (on drum)	
Ink jet printed for easy identification	
Application	For special requirements in open pit and especially underground mining. For extreme high mechanical stress in particular for high tensile and abrasion stress. They serve to connect heavy, self-driven loaders, shuttle cars etc., which are supplied with electrical power by using cable reels. In addition to that they can be used in dry, moist and wet rooms as well as outdoors e.g. on sites
Standard length cable packing	300 m on drums. Other forms of packing and delivery are available on request
Approvals	MSHA:P-07-KA120001-1-MSHA

Number and cross-section of power + grounding conductors	Power conductor stranding	Grounding/Ground check conductor stranding	Nominal insulation thickness	Nominal jacket thickness	Approximate overall diameter	Maximum conductor resistance at 20°C	Ampacity at ambient temperature 30°C	Approximate weight of cable
mm ²	N x mm	N x mm	mm	mm	mm	Ω/km	A	kg/km
6/10 kV								
3x50+2x16+1x10	364x0.4	116x0.4/74x0.4	3.4	5.5	54.0	0.393	202	4307
3x70+2x35+1x10	514x0.4	254x0.4/74x0.4	3.4	5.5	54.8	0.277	250	5534
3x95+2x35+1x16	684x0.4	254x0.4/116x0.4	3.4	5.5	62.6	0.210	301	6901
3x120+2x50+1x10	870x0.4	364x0.4/74x0.4	3.4	5.5	66.3	0.164	352	7467
3x185+2x70+1x35	1325x0.4	514x0.4/254x0.4	3.4	5.5	75.6	0.108	461	11100
8.7/15 kV								
3x50+2x16+1x10	364x0.4	116x0.4/74x0.4	4.5	5.5	60.3	0.393	215	4900
3x70+2x35+1x10	514x0.4	254x0.4/74x0.4	4.5	5.5	63.2	0.277	265	6100
3x95+2x35+1x16	684x0.4	254x0.4/116x0.4	4.5	5.5	68.2	0.210	319	7100
3x120+2x50+1x10	870x0.4	364x0.4/74x0.4	4.5	5.5	72.2	0.164	371	8400
3x185+2x70+1x35	1325x0.4	514x0.4/254x0.4	4.5	5.5	76.7	0.108	488	12100
14/25 kV								
3x50+2x16+1x10	364x0.4	116x0.4/74x0.4	6.8	5.5	65.1	0.393	215	6800
3x70+2x35+1x10	514x0.4	254x0.4/74x0.4	6.8	5.5	69.7	0.277	265	8000
3x95+2x35+1x16	684x0.4	254x0.4/116x0.4	6.8	5.5	75.3	0.210	319	9000
3x120+2x50+1x10	870x0.4	364x0.4/74x0.4	6.8	5.5	78.3	0.164	371	9400
3x185+2x70+1x35	1325x0.4	514x0.4/254x0.4	6.8	5.5	86.3	0.108	488	14000

(N)TMH3S 0.6/1kV

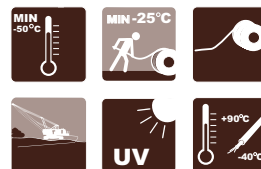

Round portable mining cable	
Standards: In line with IEC 60502-1	
CONSTRUCTION	
Conductors	Finely stranded bare copper, flexible, class 5 in accordance with IEC 60228
Separator	If needed a suitable tape separator between the conductor and insulation
Insulation	Ethylene-Propylene Rubber (EPR) 90°C type 3GI3 acc. to DIN VDE 0207, p. 20
Circuit identification	Colour of insulation: brown, black, grey, earth - green/yellow
Assembly	Three power, and three insulated earth cores cabled together. Rubberized cotton binder tape applied overall
Jacket	Thermoplastic Polyurethane (TPU). Abrasion, impact, tear and oil resistant
Colour of outer jacket	Yellow
CHARACTERISTICS	
Excellent impact and abrasion resistance	
Excellent flexibility	
Highly ozone and weather resistant	
Temperature range: fixed installation -50°C up to 90°C, mobile installation -40°C up to 90°C	
Maximum conductor operating temperature: 90°C	
Maximum short-circuit current temperature: 250°C	
Oil and heat resistance	
Voltage test: Power -3,5 kV in AC/ 5min, Insulated Earth -2,0 kV in AC/5 min	
Minimum bending radius: Fixed installation 6 x d, mobile 8 x d; s-shape deflection: 20 x d, d-cable outer diameter	
Ink jet printed for easy identification	
Application	For extreme high mechanical stress in particular for high tensile and abrasion stress. Specially designed for reeling applications. They serve to connect heavy, self-driven loaders, shuttle cars etc., which are supplied with electrical power by using cable reels. In addition to that they can be used in dry, moist and wet rooms as well as outdoors e.g. on sites Other industrial applications
Standard length cable packing	300 m on drums. Other forms of packing and delivery are available on request

Number and cross-section of power + grounding conductors	Power conductor stranding	Nominal insulation thickness	Minimum/Approx./Maximum overall diameter	Maximum conductor resistance at 20°C	Ampacity* at ambient temperature 30°C	Approximate weight of cable
mm ²	N x mm	mm	mm	Ω/km	A	kg/km
3x25+3G6	180x0.4	1.4	23.5/25.5/26.0	0.780	121	1252
3x35+3G6	254x0.4	1.4	27.0/27.1/29.5	0.554	150	1556
3x50+3G10	364x0.4	1.6	30.0/33.2/33.7	0.386	182	2293
3x70+3G16	514x0.4	1.6	35.0/38.0/39.5	0.272	234	3164
3x95+3G16	684x0.4	1.8	39.0/43.6/44.1	0.206	284	4016
3x120+3G25	870x0.4	1.8	44.0/45.8/47.0	0.161	330	4987
3x150+3G25	1092x0.4	2.0	49.0/51.9/52.5	0.129	375	6122
3x185+3G35	1325x0.4	2.2	54.5/57.5/58.5	0.106	429	7541
3x240+3G50	1752x0.4	2.4	60.5/62.7/64.5	0.0801	510	9737
3x300+3G50	2203x0.4	2.6	68.5/72.5/73.0	0.0641	555	12029

* Current carrying capacities are given for an uncoiled cable laid on the ground, a conductor temperature of 90°C and ambient temperature of 30°C. Correction factors must be apply for other conditions

** Other composition can be manufactured on request as e.g. composite cables including power and earth cores

(N)TSKCGEWÖU 3.6/6 (7.2) kV

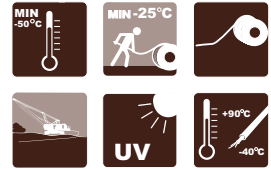

Medium voltage trailing cables	
Standards: based on DIN VDE 0250 p. 813	
CONSTRUCTION	
Conductors	Annealed flexible stranded tin coated class 5 to IEC 60228, HD 383
Separator	If needed a suitable semi-conductive tape between the conductor and insulation
Conductor screen	Semi-conductive layer
Insulation	Ethylene-propylene rubber (EPR) type 3GI3 to DIN VDE 0207 p. 20
Insulation screen	Semi-conductive layer Max. resistivity of semi-conductive layers - 200 Ω x m
Core cable	Three power, two earth and one pilot laid up on cradle separator with Kevlar reinforcement in centre
Semi-conductive covering	Semi-conductive layer over core of cable
Internal layer of sheath	A synthetic thermosetting compound type 5GM5 to DIN VDE 0207 part 21
Anti-torsion braid	Braid of polyamide threads between internal and outer layer of sheath
Outer layer of sheath	A synthetic thermosetting compound type 5GM5 to DIN VDE 0207 part 21
Colour of outer jacket	Black
CHARACTERISTICS	
Excellent tear, impact and abrasion torsion resistant	
Flame retardant and oil resistant	
Temperature range -50°C to +90°C	
UV, sunlight, ozone, oil resistant	
Embossing marking for easy identification	
Application	For connection of large material handling machines such as excavators, dumpers, crushers in open-cast mines Cables are suitable for high mechanical stresses in conjunction with mono spiral reels and cylindrical reels Other industrial applications
Standard length cable packing	500 m on drums. Other forms of packing and delivery are available on request

Number of cores Cross-section	Conductor diameter	Approximate overall diameter	Approximate weight	Conductor resistance at 20°C	Current-carrying capacity at 30°C
mm ²	mm	mm	kg/km	Ω/km	A
3.6/6 kV (N)TSKCGEWÖU					
3x25+2x16+2x16	6.30	41.80	2835	0.795	132
3x35+2x16+1x16	7.00	44.40	3214	0.565	161
3x50+2x16+1x16	9.00	48.70	3922	0.393	202
3x70+2x25+1x25	10.80	53.70	5140	0.277	251
3x95+2x25+1x25	13.00	59.10	6172	0.210	301
3x120+2x35+1x35	14.10	70.00	6750	0.164	351
3x150+2x35+1x35	16.00	78.00	8152	0.132	405
3x185+2x50+1x50	18.20	82.00	9670	0.108	462

PHYSICAL PARAMETERS

Outer sheath

Tensile tests shall value as follows:

Un aged test pieces	Tensile strength min. 15 N/mm ²
	Elongation at break min. 300%
Ageing in air oven	100°C, 168 h
	Change TS +/- 30%, EB +/- 40%
After ageing in oil	100°C, 24 h
	Change TS and EB +/- 40%
Tear resistance	Value of min. 30 N/mm

ELECTRICAL PARAMETERS

Current-carrying capacity: according to DIN VDE 0298 part 4

Conversion factor for current rating ambient temperatures deviating from 30°C

Ambient temp. °C	20	25	30	35	40	45	50
Conversion factor	1.09	1.05	1.0	0.92	0.88	0.83	0.78
Voltage tests	Cables shall be tested in air and withstand voltage test applied: between power, earth conductors and screen in accordance to DIN VDE 0250 part 813						
Partial discharge	max . 20 pC						

THERMAL PARAMETERS

Ambient temperature	for fixed installation +90°C/-50°C
Maximum permissible operating temperature of conductor	90°C
Short-circuit temperature of conductor	250°C

MECHANICAL PARAMETERS

Smallest admissible bending radius (for fixed installation)	6 x D, D=cable diameter
Tensile load up to 20N/mm ²	

CHEMICAL PARAMETERS

Resistance to oil	DIN VDE, part 811-2-1 p. 10
Weather resistance	resistant to ozone, UV and moisture

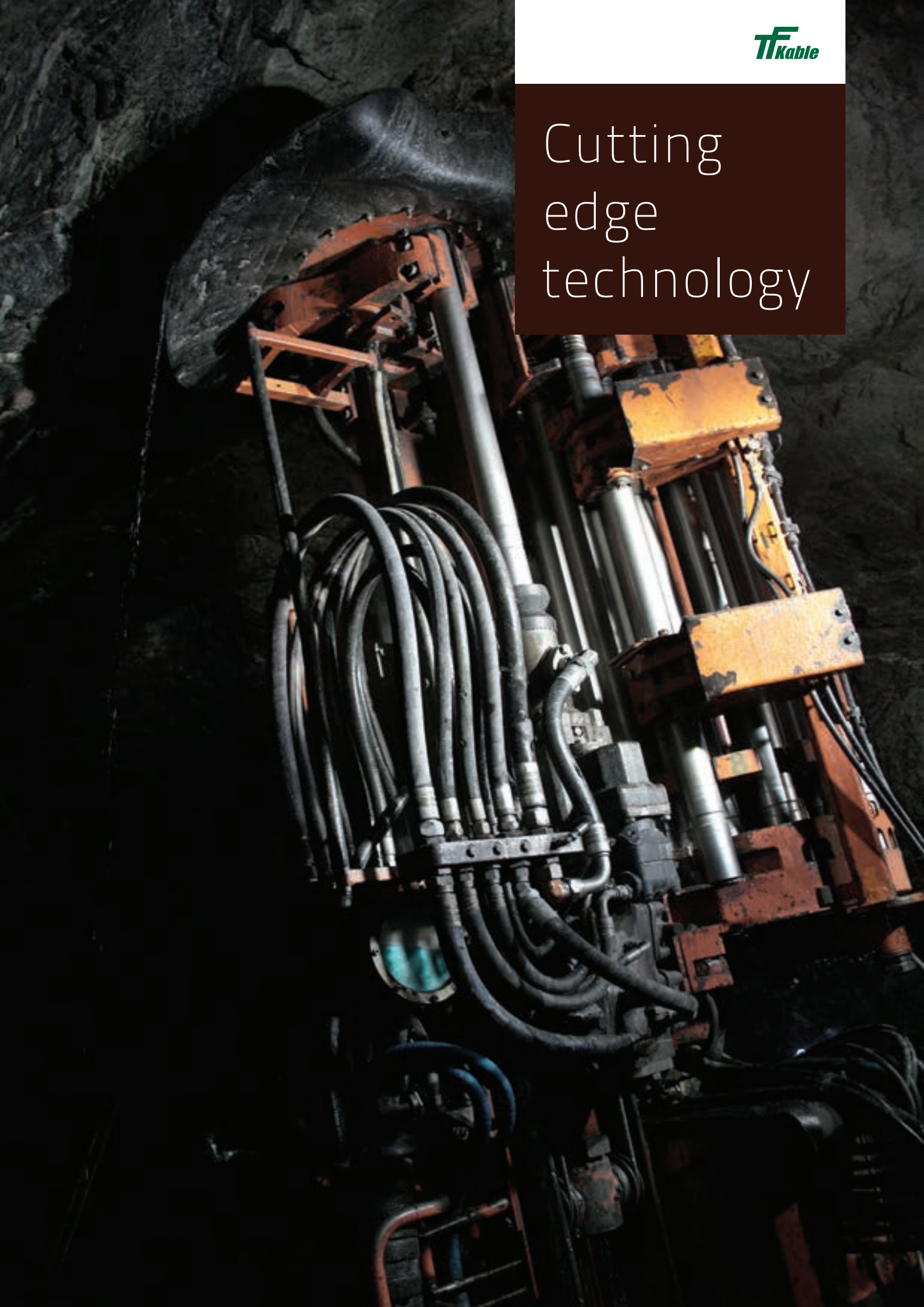
A close-up, low-angle shot of a large piece of mining machinery, likely a rock drill or cutter, positioned in a dark, rocky tunnel. The machine is complex, with various hydraulic cylinders, hoses, and metal components. The lighting is dramatic, highlighting the textures of the rock and the metallic surfaces of the equipment. A dark, semi-transparent rectangular box is overlaid on the right side of the image, containing the text 'Cutting edge technology' in white.

Cutting
edge
technology

NTSKCGWÖU 0.6/1 (1.2) kV

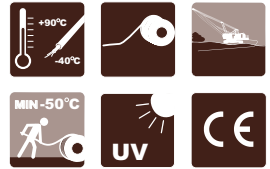
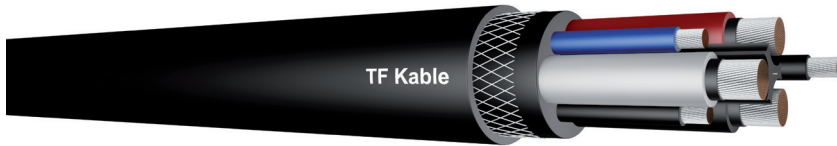

Loader cables	
Standards: DIN VDE 0250 p. 813	
CONSTRUCTION	
Conductors	Annealed flexible stranded tin coated copper class 5 to IEC 60228
Separator	If needed a suitable semi-conductive tape between the conductor and insulation
Insulation	Ethylene-propylene rubber (EPR) type 3GI3 to DIN VDE 0207 part 20
Pilot cores	Tinned copper conductors Class 5 with EPR insulation
Earth core	Tinned copper conductors Class 5 covered semi-conductive compound
Core of cable	Three power, one earth and two pilots laid up on cradle separator with kevlar reinforcement in centre
Semi-conductive covering	Semi-conductive layer over core of cable
Internal layer of sheath	A synthetic thermosetting compound type 5GM5 to DIN VDE 0207 part 21
Anti-torsion braid	Braid of polyamide threads between internal and outer layer of sheath
Outer layer of sheath	A synthetic thermosetting compound type 5GM5 to DIN VDE 0207 p. 21
Colour of outer jacket	Black
CHARACTERISTICS	
Excellent tear, impact and abrasion torsion resistant	
Flame retardant and oil resistant	
Temperature range -50°C to +90°C	
Bending radius 4 x D, D=diameter of cable	
UV, sunlight, ozone and oil resistant	
Marking for easy identification	
Application	For connection of material handling machines as loaders in mines Other industrial applications
Standard length cable packing	500 m on drums. Other forms of packing and delivery are available on request

Number of cores Cross-section	Range overall diameter Min.-Approx.-Max.	Approximate weight	Conductor resistance at 20°C	Inductive reactance at 50 Hz	Capacitance	Short circuit capacity	Current- carrying capacity at 30°C
mm ²	mm	kg/km	Ω/km	Ω/km	μF/km	kA	A
3x16+1x6+2x6P	32.0-32.3-35.0	1526	1.24	0.089	0.39	2.3	99
3x25+1x6+2x6P	37.0-37.4-40.0	2097	0.795	0.088	0.42	3.6	131
3x50+1x10+2x10P	44.0-45.1-50.0	3357	0.565	0.082	0.32	6.4	202

PHYSICAL PARAMETERS

Outer sheath

Tensile tests shall value as follows:

Un aged test pieces	Tensile strength min. 15 N/mm ²
	Elongation at break min. 300%
Ageing in air oven	100°C, 168 h
	Change TS +/- 30%, EB +/- 40%
After ageing in oil	100°C, 24 h
	Change TS and EB +/- 40%
Tear resistance	Value of min. 30 N/mm

ELECTRICAL PARAMETERS

Current-carrying capacity: according to DIN VDE 0298 part 4

Voltage tests	Cables shall be tested in air and withstand voltage test applied: between power, earth conductors and screen in accordance to DIN VDE 0250 part 813
---------------	---

THERMAL PARAMETERS

Ambient temperature	for fixed installation +90°C/-50°C
Maximum permissible operating temperature of conductor	90°C
Short-circuit temperature of conductor	250°C

MECHANICAL PARAMETERS

Smallest admissible bending radius	4xD, D=cable diameter
Tensile load up to 20N/mm ²	

CHEMICAL PARAMETERS

Resistance to oil	DIN VDE, part 811-2-1 p. 10
Weather resistance	resistant to ozone, UV and moisture

NTSKCGWÖU 0.6/1 (1.2) kV KON

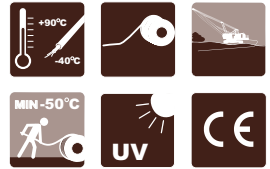
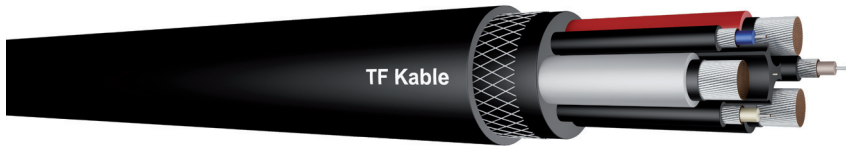

Loader cables	
Standards: DIN VDE 0250 p. 813	
CONSTRUCTION	
Conductors	Annealed flexible stranded tin coated copper class 5 to IEC 60228
Separator	If needed a suitable semi-conductive tape between the conductor and insulation
Insulation	Ethylene-propylene rubber (EPR) type 3GI3 to DIN VDE 0207 part 20
Pilot cores	Tinned copper wires stranded on reinforcing yarns with EPR insulation
Earth core	The wrap of tinned copper strands covered semi-conductive layer
Core of cable	Three power and three concentric pilot/earth cores laid up on cradle separator with kevlar reinforcement in centre
Semi-conductive covering	Semi-conductive layer over core of cable
Internal layer of sheath	A synthetic thermosetting compound type 5GM5 to DIN VDE 0207 part 21
Anti-torsion braid	Braid of polyamide threads between internal and outer layer of sheath
Outer layer of sheath	A synthetic thermosetting compound type 5GM5 to DIN VDE 0207 p. 21
Colour of outer jacket	Black
CHARACTERISTICS	
Excellent tear, impact and abrasion torsion resistant	
Flame retardant and oil resistant	
Temperature range -50°C to +90°C	
Bending radius 2.3 x D, D=diameter of cable	
UV, sunlight, ozone and oil resistant	
Embossing marking for easy identification	
Application	For connection of material handling machines as loaders in mines Other industrial applications
Standard length cable packing	500 m on drums. Other forms of packing and delivery are available on request

Number of cores Cross-section	Range overall diameter Min.-Approx.-Max.	Approximate weight	Conductor resistance at 20°C	Inductive reactance at 50 Hz	Capacitance	Short circuit capacity	Current- carrying capacity at 30°C
mm ²	mm	kg/km	Ω/km	Ω/km	μF/km	kA	A
3x16+3(1.5KON+16/3KON)	37.3-42.0	2060	1.24	0.089	0.39	2.3	99
3x25+3(1.5KON+25/3KON)	39.1-44.0	2428	0.795	0.088	0.42	3.6	131
3x50+3(1.5KON+25/3KON)	45.1-54.0	3467	0.565	0.083	0.32	6.4	202

PHYSICAL PARAMETERS

Outer sheath

Tensile tests shall value as follows:

Un aged test pieces	Tensile strength min. 15 N/mm ²
	Elongation at break min. 300%
Ageing in air oven	100°C, 168 h
	Change TS +/- 30%, EB +/- 40%
After ageing in oil	100°C, 24 h
	Change TS and EB +/- 40%
Tear resistance	Value of min. 30 N/mm

ELECTRICAL PARAMETERS

Current-carrying capacity: according to DIN VDE 0298 part 4

Voltage tests	Cables shall be tested in air and withstand voltage test applied: between power, earth conductors and screen in accordance to DIN VDE 0250 part 813
---------------	---

THERMAL PARAMETERS

Ambient temperature	for fixed installation +90°C/-50°C
Maximum permissible operating temperature of conductor	90°C
Short-circuit temperature of conductor	250°C

MECHANICAL PARAMETERS

Smallest admissible bending radius	4xD, D=cable diameter
Tensile load up to 20N/mm ²	

CHEMICAL PARAMETERS

Resistance to oil	DIN VDE, part 811-2-1 p. 10
Weather resistance	resistant to ozone, UV and moisture

RIT-(N)TMCGETMPU 6/10 kV to 14/25 kV



Three conductor round portable trailing cable	
Standards: IEC 60502 ,VDE 0250 part 813 , IEC 60228	
CONSTRUCTION	
Conductors	Finely stranded tinned copper, flexible, class 5 in accordance with IEC 60228
Conductor shield	Semi-conductive layer over the conductor
Insulation	Special thermosetting Ethylene-Propylene Rubber (EPR). High electrical, mechanical and temperature properties. Quality better than type 3GI3 according to DIN VDE 0207, Part 20
Insulation shield	Semi-conducting strippable layer
Ground check conductor	Annealed tin coated copper in accordance with IEC 60228. Polypropylene insulation, yellow colour
Grounding conductor (Earth)	Tinned copper conductor, flexible, finely stranded
Assembly	Three power, ground check and two grounding conductors cabled together. Semi-conducting binder tape applied overall. Integral filled jacket for higher torsion resistance
Jacket	Thermoplastic Polyurethane (TPU) compound, for extra heavy usage, oil resistant, very highly abrasion and very highly tear resistant
Colour of jacket	Yellow. Other colours can be provided
CHARACTERISTICS	
Excellent flexibility	
Highly ozone and weather resistant	
Excellent impact and abrasion resistant	
Oil and heat resistant	
Maximum conductor operating temperature: 90°C	
Maximum short-circuit current temperature: 200°C	
Rated and flexible at -30°C	
Volatage test: AC 17 kV for 6/10 kV, AC 24 kV for 8.7/15 kV, AC 36 for 14/25 kV. Time 5 min	
Minimum bending radius: ≥ 4 D fixed installation, ≥ 7.5 D free bending (on drum)	
Application	In surface and underground mines, quarries and industrial areas for connection of heavy mobile equipment such as shovels, drag lines, continuous miners, cutting and loading machines, dredges, drills, and other track equipment. For operation in extreme conditions where high mechanical stress is involved, in particular high tensile and abrasion stress. For operation in continuous reeling/unreeling applications where heavy mobile equipment is supplied with electrical power by using cable reels
Standard length cable packing	500 m on drums. Other forms of packing and delivery are available on request
Approvals	MSHA:P-07-KA120001-1-MSHA

Number and cross-section of power + grounding conductors	Power conductor stranding	Grounding/ Ground check conductor stranding	Nominal insulation thickness	Nominal jacket thickness	Approximate overall diameter	Maximum conductor resistance at 20°C	Ampacity * at ambient temperature 30°C	Approximate weight of cable
mm ²	N x mm	N x mm	mm	mm	mm	Ω/km	A	kg/km
6/10 kV								
3x70+2x35+1x35	514x0.4	254x0.4/254x0.4	2.9	5.5	53.2	0.277	250	5050
3x95+2x35+1x35	684x0.4	254x0.4/254x0.4	2.9	5.5	61.0	0.210	301	6401
3x120+2x50+1x35	870x0.4	364x0.4/254x0.4	2.9	5.5	64.7	0.164	352	7067
3x185+2x70+1x35	1325x0.4	514x0.4/254x0.4	2.9	5.5	74.0	0.108	461	10300
8.7/15 kV								
3x70+2x35+1x35	514x0.4	254x0.4/254x0.4	3.7	5.5	61.0	0.277	265	5300
3x95+2x35+1x35	684x0.4	254x0.4/254x0.4	3.7	5.5	66.0	0.210	319	6300
3x120+2x50+1x35	870x0.4	364x0.4/254x0.4	3.7	5.5	70.0	0.164	371	7600
3x185+2x70+1x35	1325x0.4	514x0.4/254x0.4	3.7	5.5	77.5	0.108	488	11300
14/25 kV								
3x70+2x35+1x35	514x0.4	254x0.4/254x0.4	5.5	5.5	67.4	0.277	265	7200
3x95+2x35+1x35	684x0.4	254x0.4/254x0.4	5.5	5.5	73.0	0.210	319	8200
3x120+2x50+1x35	870x0.4	364x0.4/254x0.4	5.5	5.5	76.0	0.164	371	8600
3x185+2x70+1x35	1325x0.4	514x0.4/254x0.4	5.5	5.5	84.0	0.108	488	13200

TRM-J 0.69/1.15 kV

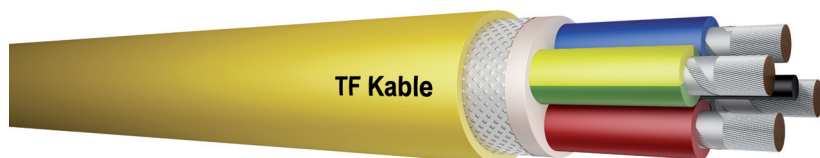

Highly flexible mining, multi-conductor rubber cables	
Standards: in line with VDE 0250 p. 812	
CONSTRUCTION	
Conductors	Flexible tinned Cu class 5 to IEC 60 228
Insulation	Ethylene propylene rubber IEP equivalent 3GI3 acc DIN VDE 0207 part 20
Circuit identification	4-core: black, blue, brown, earth: green - yellow. Multi-cores: black with numbering, earth: green - yellow
Assembly	Power cores laid up if needed around rubber filler + the wrap of PET tape
Inner sheath	Ethylene propylene rubber type EI 4 acc. DIN VDE 0207 part 20. Colour natural
Concentric screen (all sizes)	Tinned copper wires (diameter 0.30 mm) applied in the form of braid. Covering min. 90%
Separator	Polyester tape under and over the braid
Outer sheath	Synthetic thermosetting compound type 5GM3 acc. DIN VDE 0207 part 21
Colour of sheath	Yellow
Standard marking	TF Kable 3 TRM-J 0.69/1.15 kV (Year)
CHARACTERISTICS	
Excellent flexibility	
Ozone, heat, oil resistance and flame retardant	
Temperature range for mobile application -25°C to +80°C. For fixed installation from -40°C to +80°C	
Marking for easy identification	
Application	For very heavy stresses as required for mines, Shaft sinking, Harbors, Steelmills, Quarries and Oil rigs
Standard length cable packing	500 m on drums. Other forms of packing and delivery are available on request

Size	Stranding power	Nominal thickness of insulation	Nominal thickness of inner sheath	Nominal thickness of outer sheath	Approximate overall diameter of cable	Approximate weight of cable
n x mm ²		mm	mm	mm	mm	kg/km
4x2.5	45x0.25	0.9	1.2	2.0	17.3	458
4x4	51x0.3	1.0	1.2	2.0	18.9	557
4x6	76x0.3	1.0	1.2	2.0	20.7	738
4x10	74x0.4	1.2	1.4	2.2	24.3	1065
4x16	116x0.4	1.2	1.6	2.5	27.9	1483
4x25	180x0.4	1.4	1.8	3.0	33.2	2130
4x35	254x0.4	1.4	1.8	3.0	35.5	2607
4x50	364x0.4	1.6	2.0	3.5	42.6	3536
4x70	514x0.4	1.6	2.0	3.5	46.8	4799
4x95	684x0.4	1.8	2.4	4.0	55.5	6322
4x240	1752x0.4	2.4	3.2	5.0	77.7	13727
7x2.5	45x0.25	0.9	1.2	2.0	21.1	696
7x4	51x0.3	1.0	1.4	2.2	24.6	952
7x6	76x0.3	1.0	1.4	2.2	26.1	1438
12x4	51x0.3	1.0	1.6	2.0	27.0	1100
16x1	29x0.2	0.8	1.2	3.0	24.0	800
19x4	51x0.3	1.0	1.6	2.5	33.2	1776

More than
just a cable
supplier

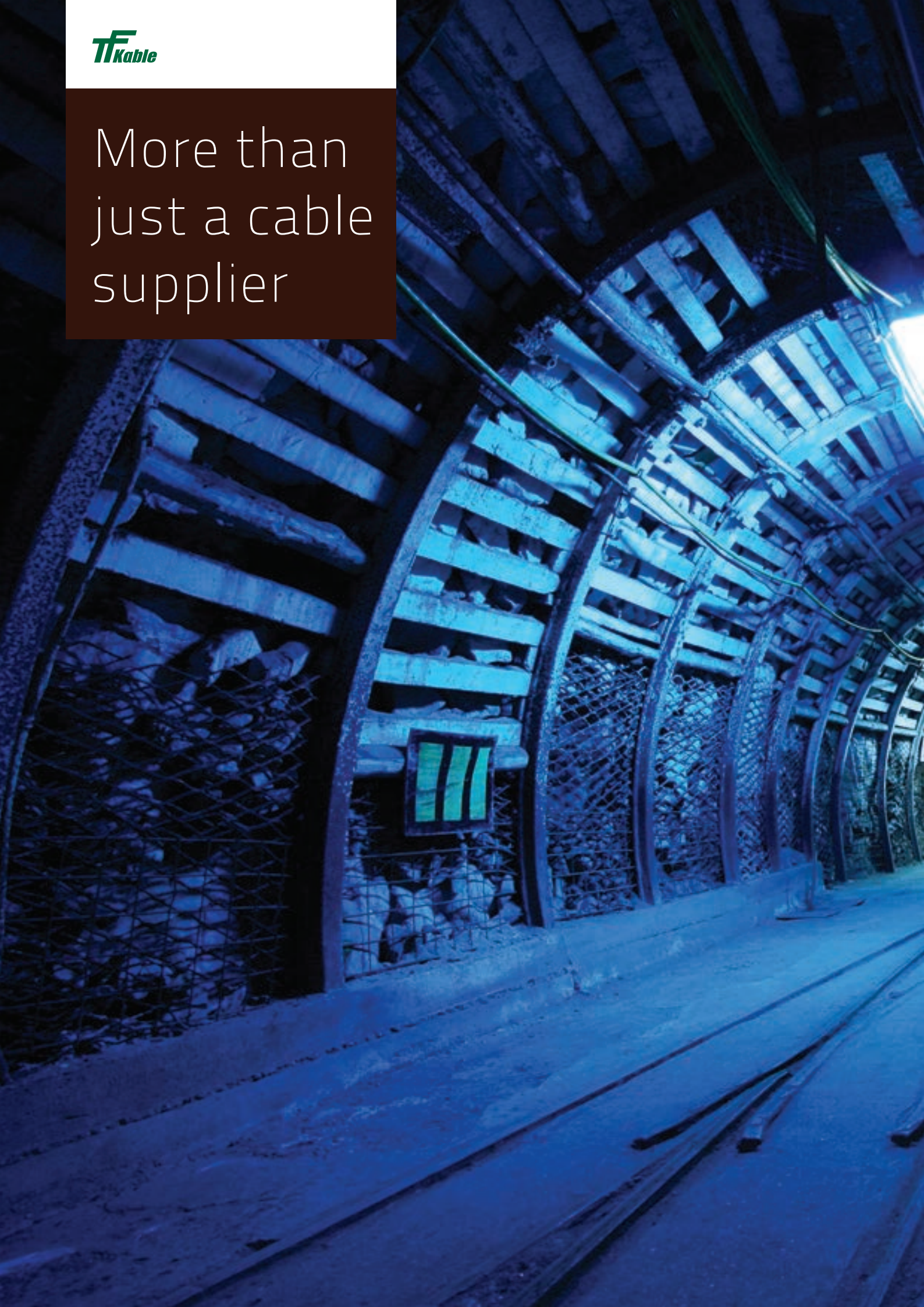

CZECH AND POLISH STANDARDS

CHCU-TT 6 kV	56
CHBU 1, 3, 6 kV	59
OnGcekzi-G 0.6/1kV	61
OnGcekz-G, OnGcekz-GW 0.6/1 kV	63
OnGcekz-G2, O2nGcekz-G2 0.6/1 kV	65
OnGcekz-G 3.6/6 kV	66
CBEH 0.6/1 kV	68
CYKYDY 0.6/1 kV	70
CHKCYDY 6 kV	71
CYKCYDY 6 kV	72
O2nGcekz/w-G(A) 1.9/3.3 kV	73
O2nGcekz/w-G(W) 3.6/6 kV	76
YHKGyFoyN 3.6/6kV	78
YKGYFoyN 3.6/6kV	80
YnOGYek	81
YnOGYekm	83

CHCU-TT 6 kV

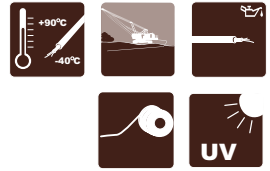
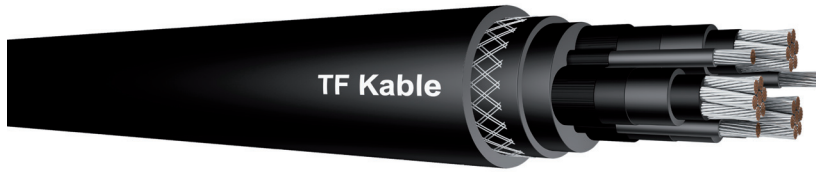

Medium voltage mining cables	
Standards: Based on DIN VDE 0250 p. 813	
CONSTRUCTION	
Conductors	Annealed flexible stranded tin coated class 5 to EN 60228
Separator	If needed a suitable semi-conductive tape between the conductor and insulation
Conductor screen	Semi-conductive layer
Insulation	Ethylene-propylene rubber (EPR) type 3GI3 to DIN VDE 0207 part 20
Insulation screen	Semi-conductive layer max. resistivity of semi-conductive layers $-200 \Omega \times m$
Power core identification	On request numbering on surface of power cores
Internal layer of sheath	Synthetic thermosetting semi-conducting compound GP comply to PN-89/E-29100
Anti-torsion braid	If needed between inner and outer sheath is torsion protecting braid from polyamide fibers
Outer layer of sheath	Synthetic thermosetting compound ON4 to PN-89/E-29100 and 5GM5 to DIN VDE 0207 part 21
Colour of outer jacket	Black or red
Standard marking	TF KABLE 3 CHCU-TT 6 kV (Size) (Year)
CHARACTERISTICS	
Excellent tear, impact and abrasion resistant	
Flame retardant	
UV, sunlight, ozone and oil resistant	
Embossing marking for easy identification	
Application	For connection of large material handling machines such as excavators, dumpers, crushers in open-cast mines Cables are suitable for high mechanical stresses in conjunction with mono spiral reels and cylindrical reels Other industrial applications
Standard length cable packing	500 m on drums. Other forms of packing and delivery are available on request

Number of cores Cross-section	Thickness of insulation	Thickness of inner and outer sheath	Approximate diameter of cable	Maximum length/flange diameter, type of drum
mm ²	mm	mm	mm	m/mm
3x16+16	3.4	1.5+3.5	50.0	800/2000, 22
3x25+16	3.4	1.5+3.5	52.0	800/2200, 22
3x35+25	3.4	1.5+4.0	53.0	750/2200, 22
3x35+3x16	3.4	1.5+4.0	48.6	900/2200, 22
3x50+3x16	3.4	1.5+4.0	53.0	750/2200, 22
3x70+3x16	3.4	2.0+4.0	57.8	600/2200, 22
3x95+3x16	3.4	2.0+4.5	64.0	550/2200, 22
3x120+3x16	3.4	2.0+4.5	66.5	500/2500, 25
3x150+3x25	3.4	2.5+4.5	73.0	400/2500, 25
3x185+3x35	3.4	3.0+4.5	76.5	300/2500, 25

PHYSICAL PARAMETERS

Insulation

Tensile tests for insulation shall value as follows:

Un aged test pieces	Tensile strength min. 6 N/mm ²
	Elongation at break min. 200%
Ageing in air oven	135°C, 168 h
	Change TS +/- 30%
	Change EB +/- 30%

Outer sheath

Tensile tests shall value as follows:

Un aged test pieces	Tensile strength min. 15 N/mm ²
	Elongation at break min. 300%
Ageing in air oven	100°C, 168 h
	Change TS +/- 30%, EB +/- 40%
After ageing in oil	100°C, 24 h
	Change TS and EB +/- 40%
Tear resistance	Value of min. 30 N/mm

ELECTRICAL PARAMETERS

Current rating in A for trailing cables 6 kV at ambient temperature of 30°C

Cross-section mm ²	Installed straightened	1 layer (reel mounted in)	2 layer	3 layer	4 layer
16	122	97	72	57	46
25	141	113	87	70	59
35	174	132	101	82	70
50	215	172	131	105	90
70	264	212	162	131	110
95	318	241	184	149	127
120	367	279	213	172	147
150	418	335	254	203	173
185	456	364	278	224	191

ELECTRICAL PARAMETERS

Current-carrying capacity: according to DIN VDE 0298 part 4

Conversion factor for current rating ambient temperatures deviating from 30°C

Ambient temp. °C	20	25	30	35	40	45	50
Conversion factor	1.09	1.05	1.0	0.92	0.88	0.83	0.78

Voltage tests

Cables shall be tested in air and withstand voltage test applied: between power, earth conductors and screen - 5 min, 17 kV

Partial discharge

max . 20 pC/9 kV

THERMAL PARAMETERS

Ambient temperature

for fixed installation +90°C/-40°C
for mobile application +60°C/-30°C

Maximum permissible operating temperature of conductor

90°C

Short-circuit temperature of conductor

250°C

MECHANICAL PARAMETERS

Smallest admissible bending radius

according to DIN VDE 0298 part 3

The manufacturer recommended as below:

for fixed installation 6 D, D - cable diameter

for mobile applications 15 D

Tensile stress +/- 100⁰/m

Tensile load as below:

Continuous tensile stress

max. 15 N/mm²

Peak dynamic stress

max. 25 N/mm²**CHEMICAL PARAMETERS**

Resistance to oil

DIN VDE, part 811-2-1 p. 10

Weather resistance

resistant to ozone, UV and moisture

CHBU 1, 3, 6 kV

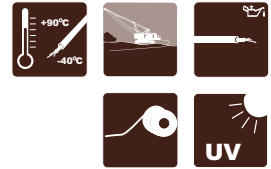

Single conductor rubber insulated and sheathed flexible power cables	
Standards: WT-TF-007:2003, DIN VDE 0250	
CONSTRUCTION	
Conductors	Annealed tinned or bare copper conductor class 5 acc. to IEC 60228
Separator	Polyester or Semi-conducting tape under insulation
Insulation	Ethylene-propylene rubber (EPR) type 3GI3/IEP to DIN VDE 0207 p. 20/PN-89/E-29100
Outer jacket	Chloroprene rubber type EM2/ON5 to DIN VDE 0207 p. 21/PN-89/29100
Colour of outer sheath	Black or other colours can be provided
Standard marking	TF KABLE 3 1-CHBU (Size) (Year)
CHARACTERISTICS	
Excellent flexibility	
Chemicals, flame retardant and weather resistant	
Temperature range -25°C to +90°C. For fixed installation lowest temperature is -40°C	
UV, sunlight, ozone, and oil resistant	
Ink jet printed for easy identification	
Application	For use in electrical installations at working voltages up to 1.3 or 6 kV Other industrial applications
Standard length cable packing	500 m on drums. Other forms of packing and delivery are available on request

Number and cross-sectional area of conductor	Nominal thickness of insulation	Nominal thickness of sheath	Approximate overall diameter	Approximate net weight of cables
mm ²	mm	mm	mm	kg/km
1-CHBU				
1x25	1.4	1.2	14.0	300
1x50	1.6	1.2	16.0	600
1x70	1.6	1.2	17.0	761
1x95	1.8	1.5	20.0	1006
1x120	1.8	1.5	21.0	1230
1x150	2.0	1.5	24.0	1576
1x185	2.2	1.5	26.0	1900
1x240	2.4	1.5	27.6	2376
1x300	2.4	2.5	32.0	2800
3-CHBU				
1x25	2.2	1.2	15.6	400
1x35	2.2	2.4	16.6	542
1x50	2.4	1.2	17.6	650
1x70	2.4	1.2	18.6	900
1x95	2.6	1.5	21.6	1200
1x120	2.6	1.5	22.6	1400
1x150	2.8	1.5	25.6	1700
1x185	3.0	1.5	27.6	2000
1x240	3.0	2.0	29.8	2570
1x300	3.4	2.5	33.0	2950
1x500	3.6	3.0	43.4	4990
6-CHBU				
1x25	3.0	1.2	17.2	470
1x50	3.0	1.2	19.2	750
1x70	3.0	1.2	20.2	1000
1x95	3.0	1.5	22.4	1300
1x120	3.0	1.5	23.4	1500
1x150	3.0	1.5	26.0	1800
1x185	3.2	1.5	28.0	2100
1x240	3.4	2.0	30.6	2800
1x300	4.0	2.5	35.2	3300

OnGcekzi-G 0.6/1 kV

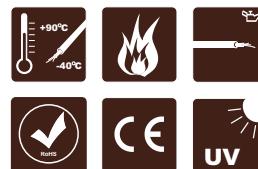

Mining flexible cables with individual screen	
Standards: ZN-96/MP-13-K1176, ZN-95/FKZ-017	
CONSTRUCTION	
Power conductors	Flexible tinned copper conductor in accordance to PN EN-60228
Separator	If needed the wrap of polyester tape
Insulation	Ethylene-propylene rubber (EPR) type IEP comply to PN-89/E-29100
Colour of insulation	Blue, natural, red. Black, grey, brown for Czech market
Insulation shield of power and pilot cores	Composite tinned copper/fibre braid. Covering 65%
Earth conductor	Flexible tinned copper conductor
Pilot	Annealed tin coated copper conductor. Colour of insulation in accordance to ZN-96/MP-13-K1176
Core of cable	Three power, and one or more pilot cores laid up on bare earth conductor
Outer layer of sheath	Poly-chloroprene thermosetting compound, heavy duty type ON-5 comply to PN-89/E-29100
Colour of sheath	Black
CHARACTERISTICS	
Highly ozone, sun, weather resistant	
Oil resistant and flame retardant outer sheath	
Ambient temperature -35°C to +55°C. Maximum conductor temperature 90°C	
Minimum bending radius 6 x diameter of cable	
Application	Extra Heavy-duty flexible mining cables for trailing applications For feeding mobile mining and industrial machines
Standard length cable packing	250 m on drums. Other forms of packing and delivery are available on request

Size	Thickness of power and pilot core insulation	Thickness of outer jacket	Approximately/ maximum overall diameter	Approximate weight	Current carrying capacity
mm ²	mm	mm	mm	kg/km	A
3x1.5+1.5+1.5	1.0	3.2	20.0	325	28
3x1.5+1.5+3x1.5	1.0	3.2	23.5	605	28
3x1.5+1.5+3x1.5	1.0	3.5	24.7/25.4	798	28
3x2.5+2.5	1.0	2.5	14.9	332	37
3x4+4	1.2	2.5	22.9	538	50
3x4+4+2x4	1.2	3.2	22.2/28.6	850	50
3x10+10+4	1.2	3.6	31.3	1393	90
3x16+10+4	1.8	4.8	34.5	1845	118
3x25+16+4	1.8	5.4	34.9	2071	152

OnGcekz-G, OnGcekz-GW 0.6/1 kV

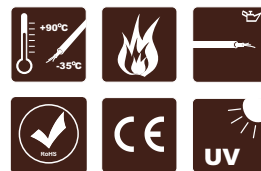
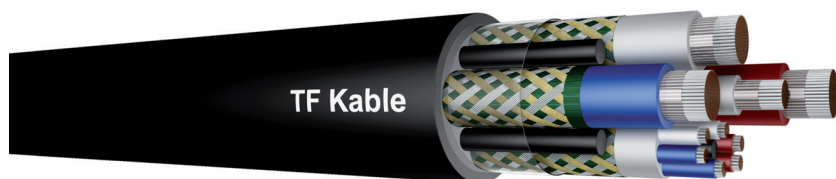

Mining flexible trailing cables	
Standards: ZN-96/MP-13-K1172	
CONSTRUCTION	
Power conductors	Flexible tinned copper conductor in accordance to PN EN-60228
Separator	The wrap of polyester tape
Insulation	Ethylene-propylene rubber (EPR) type IEP comply to PN-89/E-29100
Colour of insulation	Blue, natural, red. Black, grey, brown for Czech market
Insulation shield	Semi-conducting tape + composite tinned copper/fibre braid. Covering 30%
Earth conductor	Flexible tinned copper conductor
Pilot	Annealed tin coated copper. Colour of insulation: blue, natural, red. Colour of insulation: black, grey, brown for Czech market
Core of cable	Three power cores, the group insulated and screened pilots, laid up with rubber fillers interstitial on earth conductor. The wrap of polyester tape
Outer layer of sheath	Poly-chloroprene thermosetting compound exceed type ON4 to PN-89/E-29100
Colour of sheath	Black
CHARACTERISTICS	
Excellent impact, abrasion and tear resistant	
Oil resistant and flame retardant outer sheath	
Water resistant and flame retardant	
Ambient temperature -35°C to +55°C. Maximum conductor temperature 90°C	
Minimum bending radius 8 x diameter of cable	
Application	Extra Heavy-duty flexible mining cables for trailing applications For feeding mobile mining and industrial machines
Standard length cable packing	250 m on drums. Other forms of packing and delivery are available on request

Size	Thickness of power and pilot core insulation	Thickness of outer jacket	Approximately/ maximum overall diameter	Approximate weight	Current carrying capacity
mm ²	mm	mm	mm	kg/km	A
3x25+16+3x2.5	1.5	5.0	37.0	2164	152
3x35+16+3x2.5	1.6	5.0	38.8	2500	187
3x35+16+6x2.5	1.6	5.0	40.3	2736	187
3x50+25+3x4	1.7	5.5	45.2	3503	233
3x50+25+6x2.5	1.7	5.5	45.2	3528	233
3x70+35+3x4	1.8	5.5	50.0	4580	288
3x70+35+6x2.5	1.8	5.5	50.0	4600	288
3x70+35+6x4	1.8	5.5	50.7	4655	288
3x95+35+6x4	2.0	6.4	58.0	5917	345
3x120+50+6x4	2.2	6.4	60.6	6947	400

OnGcekz-G2, O2nGcekz-G2 0.6/1 kV

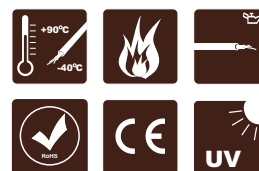

Mining flexible trailing cables	
Standards: WT-96/K-346	
CONSTRUCTION	
Power conductors	Flexible tinned copper conductor in accordance to PN EN-60228
Separator	The wrap of polyester tape
Insulation	Ethylene-propylene rubber (EPR) type IEP comply to PN-89/E-29100
Colour of insulation	Colour coding of power conductors: two red, two green, two natural. Double black, grey, brown for Czech market
Insulation shield	Semi-conducting tape + composite tinned copper/fibre braid. Covering 75%
Earth conductor	Flexible tinned copper conductor
Pilot	Annealed tin coated copper. Two red, two green, two natural. Double black, grey, brown for Czech market
Core of cable	Six power cores laid up on the group insulated and screened pilots
Outer layer of sheath	Neoprene thermosetting compound, extra heavy duty type ON-4 comply to PN-89/E-29100. In single layer for type OnGcekz-G2 or in double layer jacket with open polyamide braid for O2nGcekz-G2
Colour of sheath	Black
CHARACTERISTICS	
Excellent impact, abrasion and tear resistant	
Oil resistant and flame retardant outer sheath	
Water resistant and flame retardant	
Ambient temperature -35°C to +55°C. Maximum conductor temperature 90°C	
Minimum bending radius 8 x diameter of cable	
Application	For connection of mobile equipment and machines with very mechanical stress in mines Extra heavy-duty flexible mining cables for trailing applications For feeding mobile mining and industrial machines
Standard length cable packing	250 m on drums. Other forms of packing and delivery are available on request

Size	Thickness of power core insulation	Thickness of outer jacket	Maximum or Min./ Approx./Max. O.D.	Approximate weight	Ampacity at 25°C	Maximum recommended tension
mm ²	mm	mm	mm	kg/km	A	N
6x35+25+6x2.5	2.0	5.0	65.0	5250	150	3150
6x50+25+6x2.5	2.0	5.0	65.0	6100	188	4500
6x70+25+6x2.5	2.0	5.0	65.0	8070	230	6300
6x95+25+7x4	2.0	5.0	75.0	9300	276	8550
3x70+3x16+25+4	2.0	5.0	57.0/60.1/63.0	6470	190+117	3870
3x70+3x25+25+4	2.0	5.0	57.0/60.1/64.0	6875	190+149	4275
3x70+3x35+25+4	2.0	5.0	57.0/60.1/64.0	7015	190+180	4725

OnGcekz-G 3.6/6 kV

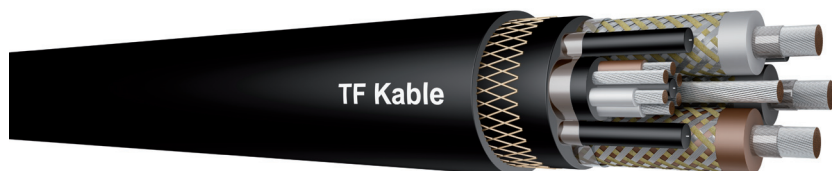

Flexible copper screened mining cables	
Standards: In line with ZN-96/MP-13-K1172	
CONSTRUCTION	
Power conductors	Tinned copper stranded acc. to PN EN-60228
Separator	The wrap of polyester tape
Insulation	Ethylene-propylene rubber (EPR) type IEP comply to PN-89/E-29100
Colour of insulation	Black, brown, grey
Insulation shield	Semi-conducting tape + composite tinned copper/fibre braid. Covering min. 65%
Earth conductor	Annealed tin coated copper conductor Class 5
Pilot	Annealed tin coated copper. Colour of insulation: brown, black, grey
Core of cable	Three power, and three or six pilot stranded, jacketed and copper/fibre braid screened laid up on bare earth conductor
Outer sheath	Poly-chloroprene thermosetting compound type ON4 to PN-89/E-29100
Voltage test	Power - 11 kV AC, Pilot - 2 kV AC
Colour of sheath	Red or black
CHARACTERISTICS	
Extra heavy duty tear, abrasion resistant outer sheath	
Oil resistant and flame retardant	
Ambient temperature -35°C to +55°C. Maximum conductor temperature 90°C	
Embossing printed of easy identification	
Application	For connection of mobile equipment and machines with very high mechanical stress, particularly in mines For feeding mobile mining and industrial machines
Standard length cable packing	250 m on drums. Other forms of packing and delivery are available on request

Size	Nominal insulation thickness	Outer jacket thickness	Maximum or Min./ Approx./Max. O.D.	Approximate weight	Ampacity	Maximum recommended tension
mm ²	mm	mm	mm	kg/km	A	N
3x35+16+3x2.5	3.4	5.5	47.0/50.1/53.0	3536	180	1575
3x35+16+3x4	3.4	5.5	47.0/50.1/53.0	3575	180	1575
3x35+16+6x2.5	3.4	5.5	47.0/50.1/53.0	3596	180	1575
3x50+25+3x2.5	3.4	5.5	52.5/54.9/58.0	4200	222	2250
3x50+25+3x4	3.4	5.5	52.5/54.9/58.0	4230	222	2250
3x50+25+6x2.5	3.4	5.5	52.5/54.1/58.0	4750	222	2250
3x50+25+6x4	3.4	5.5	52.5/54.9/58.0	4310	222	2250
3x70+35+6x4	3.4	5.5	55.6/58.6/62.0	5891	275	3150
3x70+50+3x4	3.4	5.5	58.0/63.0/68.0	4506	275	3150
3x95+35+6x4	3.4	6.4	62.0/65.4/69.0	7150	328	4275
3x95+50+3x4	3.4	6.4	62.5/65.7/69.5	7254	328	4275
3x120+50+3x4	3.4	6.4	65.0/68.3/73.0	8191	379	5400
3x50+25*	3.4	5.5	47.0/49.6/52.0	3746	222	2250

* Earth conductor 3x6 mm² bare Cu tinned class 5 laid up between power cores

CBEH 0.6/1 kV

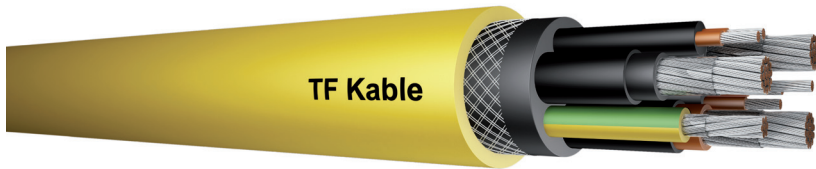

Flexible rubber insulated and sheathed mining cable	
Standards: ZN-TF-210:2008	
CONSTRUCTION	
Conductors	Annealed flexible stranded tin coated class 5 in accordance to IEC 60228
Separator	If needed a suitable tape separator between the conductor and insulation
Insulation	Ethylene-propylene rubber (EPR) type IEP in accordance to PN-89/E-29100
Insulation screen	Layer of semi-conductive rubber
Circuit identification	Power cores - black, grey, brown Earth core - green-yellow Pilot cores - black, brown, or black, grey, brown
Core of cable	Three insulated and screened power cores laid up on cradle separator with central earth conductor. Interstitial between black and brown core insulated protective core, in other pairs or three pilot cores in jacket. Length of lay maximum 9 x D, D-diameter of cable
Internal jacket	EPR thermosetting compound type EI4 in accordance to EN 50363-1
Internal covering	Semi-conductive thermosetting compound type GP in accordance to PN-89/E-29100
Concentric screen	The wrap of aluminium tape (one side polyester coating) + the braid of tinned copper wires. Covering: minimum 82%
Separator	The wrap of polyester
Outer jacket	A synthetic thermosetting compound type ON4 in accordance to PN-89/E-29100
Colour of outer jacket	Yellow or black
Voltage test	between power cores and earth - 5 min., 3.5 kV between protective core and earth conductor - 5 min., 2 kV between pilot cores - 5 min., 1 kV
Standard marking	TF KABLE 3 1-CBEH (Size) (Year)
CHARACTERISTICS	
Abrasion, oils, greases, chemicals resistant	
Flame retardant, good flexibility even at low ambient temperatures	
Temperature range -25°C to +90°C	
Embossing printed for easy identification	
Application	For various uses including mine power feeder cable for continuous miners, pump cable and power supply cable Other mining, industrial applications
Standard length cable packing	500 m on drums. Other forms of packing and delivery are available on request

Number and cross-sectional area of conductor	Size of power protective conductor	Nominal insulation thickness	Internal covering and outer sheath thickness		Minimum diameter	Approximate diameter	Maximum diameter
	mm ²	mm	mm		mm	mm	mm
3x16+10+4x2.5+hl	16 10	1.4 1.2	2.0	3.0	39.0	42.0	45.0
3x16+10+4x4+hl	16 10	1.4 1.2	2.0	3.0	39.0	42.0	45.0
3x25+16+4x4+hl	25 16	1.5 1.2	2.0	3.0	44.0	47.0	49.0
3x35+16+4x4+hl	35 16	1.6 1.2	2.0	3.5	46.0	49.0	51.0
3x50+25+4x6+hl	50 25	1.7 1.4	2.0	3.5	48.0	52.0	55.0
3x70+35+4x6+hl	70 35	1.8 1.4	2.0	4.0	53.0	56.0	59.0
3x95+50+4x6+hl	95 50	2.0 1.6	2.0	4.0	58.0	62.0	65.0
3x25+16+6x1.5+hl	25 16	1.5 1.2	2.0	3.0	44.0	47.0	49.0
3x35+16+6x1.5+hl	35 16	1.6 1.2	2.0	3.5	46.0	49.0	51.0
3x50+25+6x1.5+hl	50 25	1.7 1.4	2.0	3.5	48.0	52.0	55.0
3x70+35+6x1.5+hl	70 35	1.8 1.4	2.0	4.0	53.0	56.0	59.0

Size	Capacity	Inductance	Current-carrying capacity at 30°C	Maximum static pulling tension	Maximum dynamic pulling tension
	μF/km	mH/km	A	N	N
3x16+10+4x2.5+hl	0.26	0.34	97	720	1203
3x16+10+4x4+hl	0.26	0.34	97	720	1203
3x25+16+4x4+hl	0.31	0.31	135	1125	1880
3x35+16+4x4+hl	0.34	0.31	163	1575	2530
3x50+25+4x6+hl	0.39	0.28	205	2250	3755
3x70+35+4x6+hl	0.45	0.27	253	3150	5255
3x95+50+4x6+hl	0.53	0.26	339	4275	7125
3x25+16+6x1.5+hl	0.31	0.31	135	1125	1880
3x35+16+6x1.5+hl	0.34	0.31	163	1575	2530
3x50+25+6x1.5+hl	0.39	0.28	205	2250	3755
3x70+35+6x1.5+hl	0.45	0.31	253	3150	5255

CYKYDY-J 0.6/1 kV

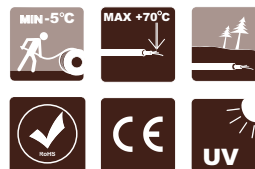

PVC insulated and PVC sheathed, round wire armoured cable	
Standards: CSN 34 7656 and CSN 34 7615	
CONSTRUCTION	
Conductors	Annealed copper solid class 1(RE), acc. to EN 60228
Insulation	Special PVC compound type DIV1 acc. to HD 603.1
Inner covering	Filling compound
Armour	Single layer of galvanized steel wires applied spirally over the bedding
Sheath	Special PVC compound type DMV1 acc.to HD 603.1
Circuit identification	4-core 5-core 7 and more
	Green-yellow, brown, black, grey Green-yellow, blue, brown, black, grey Green-yellow, other cores black with white numbering
Colour of sheath	Black
CHARACTERISTICS	
Maximum conductor operating temperature is +70°C	
Lowest ambient temperature for fixed installation is -20°C	
Lowest installation temperature is -5°C	
Maximum short-circuit conductor temperature is +160°C	
Minimum bending radius: 15 x D, D - overall diameter	
Max. permissible tensile stress with cable grip for Cu-conductor is 50 N/mm²	
Flame retardant acc. to IEC 60332-1-2	
Application	PVC insulated and PVC sheathed single round steel wires armoured cables for power networks, underground, outdoors, in water, indoors and in cable ducts if greater mechanical protection is required
Standard length cable packing	1000 m on drums. Other forms of packing and delivery are available on request

Number of cross-sectional area of conductor	Approximate overall diameter	Approximate net weight of cables	Maximum conductor resistance at temperature 20°C
n x mm ²	mm	kg/km	Ω/km
4x2.5RE	15.8	534	7.41
5X2.5RE	16.7	610	7.41
12X1.5RE	20.0	823	12.1
12X2.5RE	21.6	1003	7.41
37X2.5RE	32.0	2327	7.41

CHKCYDY 3.6/6 kV

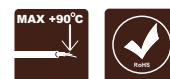

HEPR insulated and PVC sheathed power cables, concentric copper conductor and round wire armoured	
Standards: VDE 0271, IEC 60502-2	
CONSTRUCTION	
Conductors	Annealed copper conductor, circular, circular compacted or shaped stranded class 2 acc. to EN 60228
Insulation	Special compound type HEPR acc. to IEC 60502-2
Filling	Rubber compound
Concentric conductor	Semi-conductive tape, round copper wires, copper tape and plastic tape
Separation sheath	PVC compound
Armour	Single layer of galvanized steel wires applied spirally over the separation sheath with plastic tape
Sheath	PVC compound type ST, acc. to IEC 60502-2
Colour of insulation	Natural
Colour of sheath	Red
CHARACTERISTICS	
Maximum conductor operating temperature is +90°C	
Lowest ambient temperature for fixed installation is -30°C	
Lowest installation temperature is 0°C	
Maximum short-circuit conductor temperature is +250°C	
Minimum bending radius: 12 x D, for cables with circular copper conductors D - overall diameter of cable	
Flame retardant: IEC 60332-1-2	
Max. permissible tensile stress with cable grip for Cu-conductor: 50 N/mm²	
Application	For use in fixed installations in industrial areas, buildings and similar environment
Standard length cable packing	500 or 1000 m on drums. Other forms of packing and delivery are available on request

Number of cross-sectional area of conductor	Approximate overall diameter	Approximate net weight of cables	Maximum conductor resistance at temperature 20°C
n x mm ²	mm	kg/km	Ω/km
3x70/50	51.8	5993	0.268/0.387
3x95/50	55.4	7095	0.193/0.387
3x120/50	58.9	8175	0.153/0.387
3x150/50	62	9233	0.124/0.387

CYKCYDY 3.6/6 kV



PVC insulated and sheathed power cables, concentric copper conductor and round wire armoured	
Standards: VDE 0271, IEC 60502-2	
CONSTRUCTION	
Conductors	Annealed copper conductor, circular, circular compacted or shaped stranded class 2 acc. to EN 60228
Insulation	Special compound type PVC type DIV6 acc. to HD 603.1
Filling	Rubber compound
Concentric conductor	Semi-conductive tape, round copper wires, copper tape and plastic tape
Separation sheath	Single layer of galvanized steel wires applied spirally over the separation sheath with plastic tape
Sheath	PVC compound type DIV5 acc. to HD-603.1
Colour of insulation	Natural
Colour of sheath	Red
CHARACTERISTICS	
Maximum conductor operating temperature is +70°C	
Lowest ambient temperature for fixed installation is -30°C	
Lowest installation temperature is 0°C	
Maximum short-circuit conductor temperature is +150°C	
Minimum bending radius: 12 x D, for cables with circular copper conductors D - overall diameter of cable	
Test voltage: 11 kV AC 5min 50Hz	
Max. permissible tensile stress with cable grip for Cu-conductor: 50 N/mm²	
Application	For use in fixed installations in industrial areas, buildings and similar environment
Standard length cable packing	500 or 1000 m on drums. Other forms of packing and delivery are available on request

Number of cross-sectional area of conductor	Approximate overall diameter	Approximate net weight of cables	Maximum conductor resistance at temperature 20°C
n x mm²	mm	kg/km	Ω/km
3x50SM/25	48.9	5286	0.387/0.727
3X95SM/50	56.8	7553	0.193/0.387
3X150SM/50	63.5	11510	0.124/0.387

O2nGcekż/w-G(A) 1.9/3.3 kV



Flexible copper screened mining cables	
Standards: ZN-KFK-011:1999	
CONSTRUCTION	
Power conductors	Tinned copper stranded acc. to PN EN-60228
Separator	The wrap of polyester tape
Insulation	Ethylene-propylene rubber (EPR) type IEP acc. to PN-89/E-29100
Colour of insulation	Black, brown, gray
Screen	The braid of tinned copper wires and polyamide yarn. Covering min 65%
Pilot/Earth unit	Pilot core as the wrap of tinned copper wires on rubber filler. EPR insulation over the wrap. Earth core in form the wrap of tinned copper wires on insulation of pilot conductor
Core of cable	Three power cores and interstitial three pilot/Earth units laid up on rubber filler
Internal sheath	Poly-chloroprene thermosetting compound type ON5 to PN-89/E-29100
Concentric screen	Semi-conductive tape + the braid of tinned copper wires
Reinforcing braid	The braid of Kevlar strands between layers of outer sheath
Reinforcing outer sheath	Poly-chloroprene thermosetting compound type ON4 to PN-89/E-29100
Voltage test	Power - 7.5 kV AC, Pilot - 2 kV AC
Colour of sheath	Red
CHARACTERISTICS	
Extra heavy duty tear, abrasion resistant outer sheath	
Oil resistant and flame retardant	
Ambient temperature -35°C to +55°C. Maximum conductor temperature 90°C	
Minimum bending radius 2.5 x outer diameter	
Application	Extra Heavy-duty flexible mining cables for trailing applications For feeding mobile mining and industrial machines
Standard length cable packing	250 m on drums. Other forms of packing and delivery are available on request

Number of cores	Power conductors			Earth cores		Pilot cores			Nominal thickness		Approx. O.D.	Approx. weight
	Size	Max. O.D. of wires	Nominal insulation thickness	Size	Max. O.D. of wires	Number x size	Max. O.D. of wires	Nominal insulation thickness	Interanal sheath	Outer sheath		
n	mm ²	mm	mm	mm ²	mm	Nxmm ²	mm	mm	mm	mm	mm	kg/km
7	50	0.41	2.4	25	0.31	3x2.5	0.31	1.0	2.2	4.0	52.0	4947
7	70	0.41	2.4	25	0.31	3x2.5	0.31	1.0	2.2	4.0	56.7	5503
7	95	0.41	2.4	50	0.41	3.4	0.31	1.0	2.6	4.5	62.3	7604

Size	Maximum conductor resistance at temp. 20°C	Current carrying capacity at +25°C	Inductance	Reactance	Capacitance
mm ²	Ω/km	A	mH/km	Ω/km	μF/km
50	0.393	222	0.327	0.103	0.40
70	0.277	281	0.310	0.097	0.46
95	0.210	328	0.294	0.092	0.53

Tradition and modernity



O2nGcekż/w-G(W) 3.6/6 kV

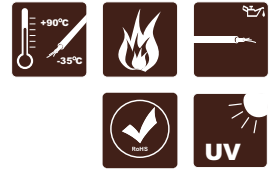

Flexible double copper screened mining cables	
Standards: ZN-KFK-011:1999	
CONSTRUCTION	
Power conductors	Tinned copper Class 5 in acc. to PN EN 60228
Separator	Over power conductors polyester foil or other non-hygroscopic material
Insulation	Of power, pilots and sheath of auxiliary conductors - from ethylene - propylene rubber type IEP acc. to PN-89/E-29100
Circuit identification	Power - natural Pilots - brown, black, grey
Screen	Metallic, made in the form of braid from galvanized copper wires and from plastic yarn of coverage density min 65%, direct over non-metallic screen, i.e. non-hygroscopic conductive tape of resistivity at 20°C max 2000 Ω x cm
Cradle separator	If needed semi-conductive compound type P acc. to PN-89/E-29100
Fillers	If needed semi-conductive compound type P acc. to PN-89/E-29100
Outer sheath	Poly-chloroprene thermosetting compound type ON5 to PN-89/E-29100
Concentric screen	Metallic, made in the form of braid from tinned copper wires and from polyamide yarns, applied over non-metallic screen
Longitudinal sealing	Tapes, swelling under the influence of water and humidity for type -GW
Outer sheath	Poly-chloroprene thermosetting compound type ON4 acc. to PN-89/E-29100
Operating temperature	-30°C to +50°C
Colour of sheath	Red or black
CHARACTERISTICS	
Extra heavy duty tear, abrasion resistant outer sheath	
Oil resistant and flame retardant	
Ambient temperature -35°C to +55°C. Maximum conductor temperature 90°C	
Application	Extra Heavy-duty flexible mining cables for trailing applications For feeding mobile mining and industrial machines
Standard length cable packing	250 m on drums. Other forms of packing and delivery are available on request

Total	Number and cross-section of conductors (n x mm ²)		
Number of conductors	Phase	Auxiliary	Protective *
1	2	3	4
4	3x25	-	1x16
	3x35	-	1x16**
	3x50	-	1x25
	3x70	-	1x25
	3x95	-	1x35
	3x120	-	1x35
7	3x25	3x2.5	1x16
	3x35	3x2.5	1x16
	3x50	3x2.5	1x25
	3x70	3x4	1x25
	3x95	3x4	1x35
	3x120	3x4	1x35
10	3x25	3x2x2.5	1x16
	3x35	3x2x2.5	1x16
	3x50	3x2x2.5	1x25
	3x70	3x2x4/3x2x6	1x25
	3x95	3x2x4/3x2x6	1x35
	3x120	3x2x4/3x2x6	1x35

* It is permissible to apply higher cross-section of phase conductors

Cable core consists of:

1. In 4-core cables: three insulated and screened power cores, three non-insulated earth/protective conductors placed in interstices between power cores, stranded around filling filler.
2. In 7-core cables: three insulated and screened power conductors, stranded over central cradle separator. Three Pilots/Earth units placed in interstices between power cores. Pilots conductors in form the wrap over rubber filler. Pilots EPR insulated. Over insulation of pilot earth/protective conductor as the wrap of tinned copper strands.
3. In 10-core cables: three insulated and screened power cores, stranded over central cradle separator. In interstices the pairs of pilots insulated, jacketed and tinned copper wires screened.

Overall dimensions

Size	Min./Approx./Max.
mm ²	mm
3x95+35	60.0/61.3/66.0
3x120+35	60.1/65.3/69.0
3x25+3x2.5+16	48.0/50.9/54.0
3x35+3x2.5+16	60.0/63.2/66.5
3x50+3x2.5+25	62.0/64.9/68.0
3x70+3x4+25	63.0/67.0/70.3
3x95+3x4+35	69.0/73.3/77.0
3x50+3x2x2.5+25	62.0/64.9/68.0
3x50+3x2x4+25	62.0/64.9/68.0
3x70+3x2x4+25	64.0/67.0/70.0
3x70+3x2x6+25	64.0/67.0/70.0
3x95+3x2x4+35	70.0/73.5/77.0
3x95+3x2x6+35	70.0/73.5/77.0

YHKGYFoy 3.6/6 kV



PVC insulated and sheathed power cables, round wire armoured	
Standards: BS EN 60228	
CONSTRUCTION	
Conductors	Annealed copper conductor, circular compacted stranded class 2 acc. to BS EN 60228
Insulation	Special compound type PVC type DIV14 acc. to PN-HD 620 S1:2002
Individual screen	Conductive non-metallic tape and copper tape
Core of cable	Three cores laid up together with central copper wire or central filer
Filling	Rubber compound
Inner sheath	PVC compound type DMV6 acc. to PN-HD 620 S1:2002
Armour	Single layer of galvanized steel wires applied spirally over the inner sheath with steel tape
Sheath	Flame retardant PVC compound type DMV31 acc. to 620 S1:2002
Colour of insulation	Natural
Colour of sheath	Red
CHARACTERISTICS	
Maximum conductor operating temperature is +70°C	
Lowest ambient temperature for fixed installation is -30°C	
Lowest installation temperature is -5°C	
Maximum short-circuit conductor temperature is +150°C	
Minimum bending radius: 12 x D, for cables with circular copper conductors D - overall diameter of cable	
Test voltage: 11 kV AC 5min 50Hz	
Flame retardant acc. to IEC 60332-3-24	
Max. permissible tensile stress with cable grip for Cu-conductor: 50 N/mm²	
Application	For use in mines for the supply of electrical energy
Standard length cable packing	500 or 1000 m on drums. Other forms of packing and delivery are available on request

Number of cross-sectional area of conductor	Approximate overall diameter	Approximate net weight of cables	Maximum conductor resistance at temperature 20°C
n x mm ²	mm	kg/km	Ω/km
3x25RMC/16	46.5	4632	0.727
3x25RMC/25	46.5	4633	0.727
3X35RMC/16	49.8	5633	0.524
3X35RMC/25	49.8	5634	0.524
3X50RMC/16	53.8	6539	0.387
3X50RMC/25	53.8	6540	0.387
3X70RMC/16	56.7	7518	0.268
3X70RMC/25	56.7	7519	0.268
3X95RMC/16	61.3	8981	0.193
3X95RMC/30	61.3	8982	0.193
3X120RMC/16	65.5	10305	0.153
3X120RMC/30	65.5	10307	0.153
3X150RMC/25	69	11629	0.124
3X150RMC/30	69	11631	0.124
3X185RMC/25	73.6	14014	0.0991
3X185RMC/30	73.6	14017	0.0991
3X240RMC/25	80.6	16863	0.0754
3X240RMC/30	80.6	16867	0.0754

YKGYFoy 3.6/6 kV



PVC insulated and sheathed power cables, round wire and steel tape armoured	
Standards: EN 60228	
CONSTRUCTION	
Conductors	Annealed copper or circular compacted stranded conductor class 2 multiwires class 2 (RMC) acc. to EN 60228
Insulation	Special compound type PVC DIV6 acc to HD 603.1
Core of cable	Three cores laid up together
Filling	Rubber compound
Inner sheath	Special black flame retardant PVC compound, type TM1 acc. to HD 603.1
Armour	Single layer of galvanized steel wires applied spirally over the bedding + binder steel tape
Sheath	Special flame retardant PVC, type TM1FR acc. to HD 603.1; colour red
Colour of insulation	Natural
Colour of sheath	Red
CHARACTERISTICS	
Maximum conductor operating temperature is +70°C	
Lowest ambient temperature for fixed installation is -30°C	
Lowest installation temperature is -5°C	
Maximum short-circuit conductor temperature is +150°C	
Minimum bending radius: 12 x D, for cables with circular copper conductors D - overall diameter of cable	
Test voltage: 11 kV AC 5min 50Hz	
Flame retardant acc. to IEC 60332-3-24	
Max. permissible tensile stress with cable grip for Cu-conductor: 50 N/mm ²	
Application	For use in mines for the supply of electrical energy
Standard length cable packing	500 or 1000 m on drums. Other forms of packing and delivery are available on request

Number of cross-sectional area of conductor	Approximate overall diameter	Approximate net weight of cables	Maximum conductor resistance at temperature 20°C
n x mm ²	mm	kg/km	Ω/km
3x95/50	61.0	9525	0.193/0.387
3x150/50	68.6	12185	0.124/0.387
3x185/27	71.0	13578	0.0991/0.727

YnOGYek 0.6/1 kV



PVC insulated and sheathed low voltage mining cable rated at 0.6/1 kV	
CONSTRUCTION	
Conductors	Cu class 5 acc. to EN 60228
Insulation	PVC
Insulation screen (power cores)	Extruded layer of semi-conducting thermoplastic compound
Laying-up	Three insulated and screened power cores and one insulated signaling conductor laid up around bare earth conductor
Sheath	Special PVC flame retardant, oxygen index min. 29
Colour of sheath	Yellow
Colour code	Power cores - white (natural PVC) Insulated signaling conductor - red
Minimum bending radius	For fixed installation 6 D For movable appliances 12 D, D - cable overall diameter
CHARACTERISTICS	
Maximum conductor operating temperature: +70°C	
Application	For powering underground mining equipment For use in underground mines, in methane and methane-free areas in headings of "A", "B", or "C" degree of methane explosion hazard and of "A" or "B" degree of coal dust explosion hazard
Test voltage	Power cores 3.2 kV Insulated signaling conductor 2 kV

Number and cross-sectional area of conductor	Nominal thickness of insulation			Thickness of extruded screen	Nominal thickness of sheath		Max. cable diameter	Approximate weight of 1kkm of cable	Max. DS resistance of power core at 20°C
	Power cores	Signaling	Bare earth		Inner	Outer			
n x mm ²	mm			mm	mm		mm	kg	Ω/km
3x2.5+2.5+2.5	1.0	1.0	-	0.5	1.0	2.0	23	490	7.98
3x4+4+4	1.0	1.0	-	0.5	1.0	2.0	23	650	4.98
3x6+6+4	1.2	1.0	-	0.6	1.0	2.2	29.5	1000	3.30
3x10+10+6	1.4	1.2	-	0.6	1.0	2.2	32.5	1350	1.91

Maximum resistance of bare earth and insulated signaling conductor is equal to maximum resistance of power cores of adequate sizes as per above table

Nominal size of power core	DC or AC current carrying capacity at ambient temperature max. +25°C	Inductance	Inductive reactance	Capacitance to earth
mm ²	A	mH/km	Ω/km	μF/km
2.5	27	0.40	0.126	0.42
4	37	0.36	0.113	0.55
6	47	0.35	0.110	0.57
10	66	0.33	0.104	0.62

Transition resistance between screen and earth conductor calculated as an arithmetic mean of at least five measurements for each power conductor should not be greater than 2000 Ω, while the maximum value of individual measurements should not be greater than 4200 Ω.

Nominal sizes of power cores, bare earth conductor and insulated signaling conductor

Number of cores in the cable	Nominal size		
	Power core	Bare earth	Signaling
N	mm ²		
5	2.5	2.5	2.5
	4	4	4
	6	6	4
	10	10	6

YnOGYekm 0.6/1 kV



PVC insulated and sheathed low voltage mining cable rated at 0.6/1 kV	
CONSTRUCTION	
Conductors	Cu class 5 acc. to IEC 228
CSA of power cores	4 mm ²
CSA of control core	4 mm ²
CSA of protective conductor	4 mm ²
Colour code	Power cores: all 3 cores in natural colour (white) Control core: red
Insulation thickness	Power cores: 1.0 mm Control core: 1.0 mm
Power cores insulation screen	Braid consist of Cu wires with diameter 0.2 mm and plastic yarn. Minimum braiding density of Cu wires 65%
Laying up	Three power cores and control core laid up around not insulated protective conductor
External sheath thickness (mm)	3.0
Colour of the sheath	Yellow
Approximate overall diameter of the cable (mm)	18.8
Calculated weight of the cable (kg/km)	562
CHARACTERISTICS	
Long-term current carrying capacity at DC or AC at calculated ambient temperature not higher than +25°C (A)	37
Inductance (mH/km)	0.36
Inductive reactance (Ω/km)	0.113
Capacitance to earth (μF/km)	0.55
Working temperature	70°C
Application	For underground mining equipment

Focused on
the future



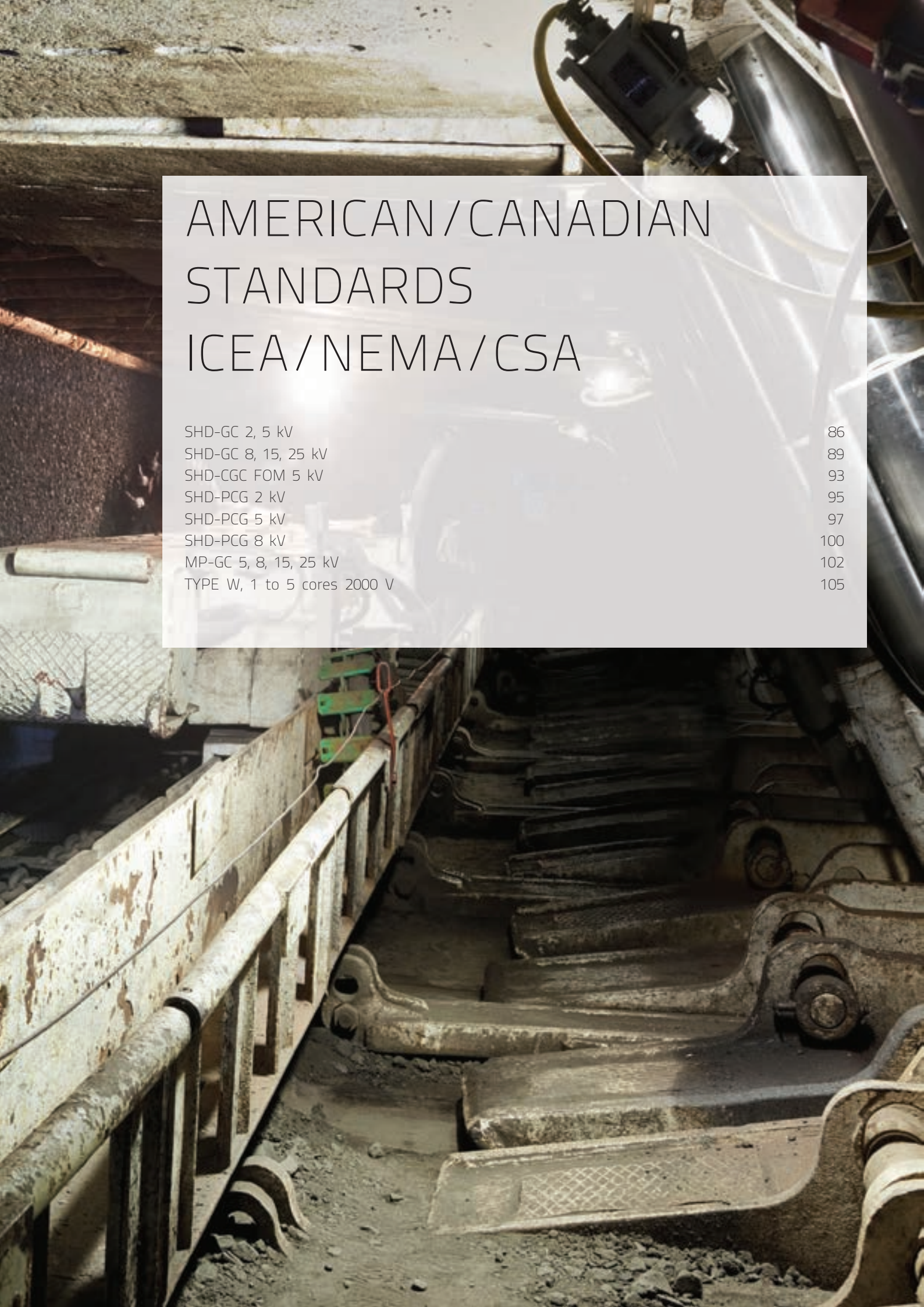

AMERICAN/CANADIAN STANDARDS ICEA/NEMA/CSA

SHD-GC 2, 5 kV	86
SHD-GC 8, 15, 25 kV	89
SHD-CGC FOM 5 kV	93
SHD-PCG 2 kV	95
SHD-PCG 5 kV	97
SHD-PCG 8 kV	100
MP-GC 5, 8, 15, 25 kV	102
TYPE W, 1 to 5 cores 2000 V	105

SHD-GC 2, 5 kV

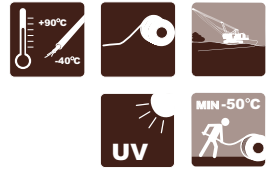
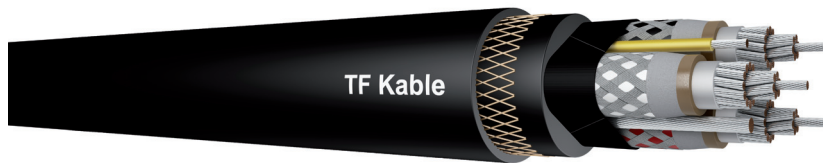

Round portable power cables, mining grade	
Standards: ICEA S-75-381/NEMA WC-58	
CONSTRUCTION	
Conductors	Annealed flexible stranded tinned copper ASTM B 172 and ICEA S-75-381, Tab. 3-22
Separator	Polyester tape between conductor and insulation. ICEA S-75-381
Insulation	Ethylene-propylene rubber (EPR). ICEA S-75-381, Tab. 3-22
Insulation shield	None-conducting bedding tape + Composite tinned copper/polyamide braid. Coverage minimum 60%
Circuit identification	The polyamide in the shielding braid is coloured black, white, red in accordance with ICEA S-75-381
Grounding	Annealed tin coated copper acc. Tab. 3-25 of ICEA S-75-381
Ground check	Yellow polypropylene - insulated tinned copper conductor. ICEA S-75-381 Tab. 3-22
Assembly	Three power, the ground check, two non-insulated grounding cabled together to form a round cable core
Separator	Polyamide open braid applied overall
Outer jacket	Black, extra heavy duty, high torsion resistant, integral-filled, reinforced poly-chloroprene thermosetting jacket, ICEA S-75-381 Tab. 3-3, 3-22, Sec.3.21. TPU optional jacket available
Colour of outer jacket	Black or other colours can be provided
Minimum bending radius	Eight times overall diameter of the cable
CHARACTERISTICS	
Excellent flexibility	
Highly ozone, sun, weather and flame resistant	
Rated and flexible at -50°C	
Excellent impact and abrasion resistant	
Oil and heat resistant	
Indent printed for easy identification	
Application	Use on AC off track equipment such as long wall miners loaders, drills, shovels, conveyors, pumps, and mobile equipment requiring grounding conductors and a ground check conductor and metallic shielding overall Other industrial, mining applications Maximum continuous conductor temperature is 90°C
Standard length cable packing	1000 ft on drums. Other forms of packing and delivery are available on request
Approvals	MSHA: P-07-KA060012

SHD-GC 2 kV

Selection data

Power conductor size	Power conductor stranding		Nominal thickness of insulation	Jacket thickness	Grounding conductor			Approximate weight		Approximate overall diameter	Maximum permissible tensile force
					Size	Stranding					
AWG or MCM			Inches	Inches	AWG			lbs./1000 ft	kg/km	Inches	N
12*	49	7x7	0.070	0.125	12	49	7x7	557	829	0.92	148
10*	49	7x7	0.070	0.125	12	49	7x7	623	927	0.95	238
8*	133	7x19	0.070	0.155	10	49	7x7	818	1217	1.13	380
6	133	7x19	0.070	0.155	10	49	7x7	1076	1601	1.26	600
4	259	7x37	0.070	0.155	8	133	7x19	1308	1947	1.36	950
2	259	7x37	0.070	0.170	6	133	7x19	1874	2789	1.55	1500
1	259	7x37	0.080	0.170	5	133	7x19	2340	3482	1.71	1900
1/0	266	19x14	0.080	0.190	4	259	7x37	2694	4009	1.81	2400
2/0	342	19x18	0.080	0.205	3	259	7x39	3301	4913	1.94	3000
3/0	418	19x22	0.080	0.205	2	259	7x37	3890	5775	2.07	3800
4/0	532	19x28	0.080	0.220	1	259	7x37	4701	6996	2.24	4800
250	627	19x33	0.095	0.220	1/0	266	19x14	5637	8390	2.44	5800
300	740	37x20	0.095	0.235	1/0	266	19x14	6815	10143	2.70	6825
350	888	37x24	0.095	0.235	2/0	342	19x18	7194	10707	2.73	7900
500	1221	37x33	0.095	0.265	4/0	532	19x28	9611	14304	3.10	11400

* Based on ICEA S-75-381 NEMA WC 58

SHD-GC 2 kV

Electrical parameters

Power-grounding conductor size	Power conductor resistance at 25°C	Grounding conductor resistance at 25°C	Ground-check conductor resistance at 25°C	Inductance per unit length	Operating capacitance per unit length	Permissible short-circuit current **, **	Ampacity * 40°C ambient temperature
AWG or MCM	Ω/1000 ft	Ω/1000 ft	Ω/1000 ft	mH/1000 ft	μF/1000 ft	kA	A
6 AWG	0.436	1.109	0.679	0.118	0.09	1.90	93
4 AWG	0.274	0.697	0.679	0.107	0.11	3.03	122
2 AWG	0.172	0.436	0.679	0.101	0.13	4.80	159
1 AWG	0.137	0.349	0.679	0.100	0.13	6.06	184
1/0 AWG	0.109	0.274	0.679	0.097	0.14	7.65	211
2/0 AWG	0.0868	0.227	0.679	0.092	0.16	9.64	243
3/0 AWG	0.0688	0.172	0.679	0.091	0.17	12.15	279
4/0 AWG	0.0546	0.137	0.679	0.088	0.19	15.30	321
250 MCM	0.0466	0.109	0.436	0.084	0.21	18.16	355
300 MCM	0.0389	0.109	0.436	0.083	0.22	21.74	395
350 MCM	0.0333	0.0868	0.436	0.081	0.24	25.31	435
500 MCM	0.0233	0.0546	0.436	0.078	0.28	36.18	536

SHD-GC 5 kV											
Selection data											
Power conductor size	Power conductor stranding		Nominal thickness of insulation	Jacket thickness	Grounding conductor			Approximate weight		Approximate overall diameter	Maximum permissible tensile force
					Size	Stranding					
AWG or MCM			Inches	Inches	AWG			lbs./1000 ft	kg/km	Inches	N
6	133	7x19	0.110	0.185	10	49	7x7	1543	2296	1.51	600
4	259	7x37	0.110	0.185	8	133	7x19	1849	2752	1.60	950
2	259	7x37	0.110	0.205	6	133	7x19	2358	3509	1.79	1500
1	259	7x37	0.110	0.205	5	133	7x19	2430	3618	1.88	1900
1/0	266	19x14	0.110	0.220	4	259	7x37	3176	4728	1.98	2400
2/0	342	19x18	0.110	0.220	3	259	7x37	3689	5490	2.12	3000
3/0	418	19x22	0.110	0.235	2	259	7x37	4320	6443	2.26	3800
4/0	532	19x28	0.110	0.235	1	259	7x37	4699	6994	2.51	4800
250	627	19x33	0.120	0.250	1/0	266	19x14	5825	8670	2.57	5800
350	888	37x24	0.120	0.265	2/0	342	19x18	7414	11035	2.83	7900
500	1221	37x33	0.120	0.280	4/0	532	19x28	9602	14292	3.18	11400

SHD-GC 5 kV							
Electrical parameters							
Power-grounding conductor size	Power conductor resistance at 25°C	Grounding conductor resistance at 25°C	Ground-check conductor resistance at 25°C	Inductance per unit length	Operating capacitance per unit length	Permissible short-circuit current **	Ampacity * 40°C ambient temperature
AWG or MCM	Ω/1000 ft	Ω/1000 ft	Ω/1000 ft	mH/1000 ft	μF/1000 ft	kA	A
6 AWG	0.436	1.109	0.679	0.132	0.08	1.90	93
4 AWG	0.274	0.697	0.679	0.119	0.09	3.03	122
2 AWG	0.172	0.436	0.679	0.112	0.10	4.80	159
1 AWG	0.137	0.349	0.679	0.108	0.11	6.06	184
1/0 AWG	0.109	0.274	0.679	0.105	0.12	7.65	211
2/0 AWG	0.0868	0.227	0.679	0.099	0.14	9.64	243
3/0 AWG	0.0688	0.172	0.679	0.098	0.14	12.15	279
4/0 AWG	0.0546	0.137	0.679	0.094	0.16	15.30	321
250 MCM	0.0466	0.109	0.436	0.089	0.18	18.16	355
350 MCM	0.0333	0.0868	0.436	0.085	0.21	25.31	435
500 MCM	0.0233	0.0546	0.436	0.082	0.24	36.18	536

* Ampacity - based on continuous duty at 90°C conductor temperature
** Short-circuit current - based on conductor temperature from 90°C up to 250°C

STANDARD PRINT LEGEND:

TF KABLE (VOLTAGE) (SIZE) TYPE SHD-GC FT1 FT5 (-50°C) +90°C P-07-KA060012-MSHA

SPECIAL FACTORY OPTIONS

Jacket: Red, yellow, green orange, blue

MSHA: P-7K268101 (CPE)

Jacket: TPU Red, yellow, green orange, blue

MSHA: P-07-KA030001 (TPU)

SHD-GC 8, 15, 25 kV

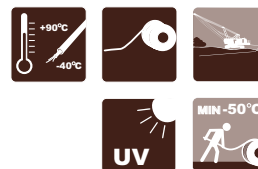
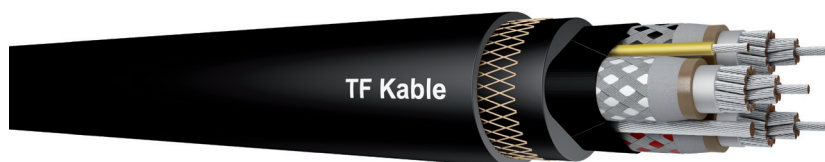

Round portable power cables, mining grade	
Standards: ICEA S-75-381/NEMA WC-58	
CONSTRUCTION	
Conductors	Annealed flexible stranded tin coated copper in accordance with ASTM B 172 and ICEA S-75-381, Tab. 3-22
Conductor shield	Semi-conductive layer over the conductor
Insulation	Ethylene-propylene rubber (EPR)
Insulation shield	Semi-conducting tape +Composite tinned copper/polyamide braid. Covering minimum 60%
Circuit identification	The polyamide in the shielding braid is coloured black, white, red in accordance with ICEA S-75-381
Grounding	Annealed tin coated copper acc. Tab. 3-25 of ICEA S-75-381
Ground check	Yellow polypropylene - insulated tinned copper conductor. ICEA S-75-381 Tab. 3-22
Assembly	Three power, the ground check, two bare grounding cabled together to form a round cable core
Separator	A single faced rubber filled binder tape applied over core
Outer jacket	Black, extra heavy duty, high torsion resistant, integral-filled, reinforced poly-chloroprene thermosetting jacket, ICEA S-75-381 Tab. 3-3, 3-22, Sec.3.21. TPU optional jacket available
Colour of outer jacket	Black or other colours can be provided
Minimum bending radius	Eight times overall diameter of the cable
CHARACTERISTICS	
Excellent flexibility	
Highly ozone, sun, weather and flame resistant	
Rated and flexible at -40°C. In black poly-chloroprene and all colours TPU jackets suitable for -50°C	
Excellent impact and abrasion resistant	
Oil and heat resistant	
Indent printed for easy identification	
Application	Used for heavy mobile equipment such as draglines Shovels, dredges, drills, other track equipment Other industrial, mining applications
Standard length cable packing	1000 ft on drums. Other forms of packing and delivery are available on request
Approvals	MSHA: P-07-KA060012

SHD-GC 8 kV

Selection data

Power conductor size	Power conductor stranding		Nominal thickness of insulation	Jacket thickness	Grounding conductor			Approximate weight		Approximate overall diameter	Maximum permissible tensile force
					Size	Stranding					
AWG or MCM			Inches	Inches	AWG			lbs./1000 ft	kg/km	Inches	N
4	259	7x37	0.150	0.205	8	133	7x19	2152	3203	1.93	950
2	259	7x37	0.150	0.220	6	133	7x19	2767	3672	2.02	1500
1	259	7x37	0.150	0.220	5	133	7x19	3131	4660	2.10	1900
1/0	266	19x14	0.150	0.220	4	259	7x37	3646	5427	2.21	2400
2/0	342	19x18	0.150	0.235	3	259	7x37	4161	6193	2.34	3000
3/0	418	19x22	0.150	0.250	2	259	7x37	4912	7310	4.49	3800
4/0	532	19x28	0.150	0.250	1	259	7x37	5561	8276	2.63	4800
250	627	19x33	0.150	0.250	1/0	266	19x14	6445	9592	2.75	5800
350	888	37x24	0.150	0.280	2/0	342	19x18	8106	12064	3.05	7900
500	1221	37x33	0.150	0.295	4/0	532	19x28	10590	15762	3.39	11400

SHD-GC 8 kV

Electrical parameters

Power-grounding conductor size	Power conductor resistance at 25°C	Grounding conductor resistance at 25°C	Ground-check conductor resistance at 25°C	Inductance per unit length	Operating capacitance per unit length	Permissible short-circuit current **, **	Ampacity * 40°C ambient temperature
AWG or MCM	Ω/1000 ft	Ω/1000 ft	Ω/1000 ft	mH/1000 ft	μF/1000 ft	kA	A
6 AWG	0.436	1.109	0.679	0.132	0.08	1.90	93
4 AWG	0.274	0.697	0.679	0.119	0.09	3.03	122
2 AWG	0.172	0.436	0.679	0.112	0.10	4.80	159
1 AWG	0.137	0.349	0.679	0.108	0.11	6.06	184
1/0 AWG	0.109	0.274	0.679	0.105	0.12	7.65	211
2/0 AWG	0.0868	0.227	0.679	0.099	0.14	9.64	243
3/0 AWG	0.0688	0.172	0.679	0.098	0.14	12.15	279
4/0 AWG	0.0546	0.137	0.679	0.094	0.16	15.30	321
250 MCM	0.0466	0.109	0.436	0.089	0.18	18.16	355
350 MCM	0.0333	0.0868	0.436	0.085	0.21	25.31	435
500 MCM	0.0233	0.0546	0.436	0.082	0.24	36.18	536

* Ampacity - based on continuous duty at 90°C conductor temperature

** Short-circuit current - based on conductor temperature from 90°C up to 250°C

SHD-GC 15 kV

Selection data

Power conductor size	Power conductor stranding		Nominal thickness of insulation	Jacket thickness	Grounding conductor			Approximate weight		Approximate overall diameter	Maximum permissible tensile force
					Size	Stranding					
AWG or MCM			Inches	Inches	AWG			lbs./1000 ft	kg/km	Inches	N
2	259	7x37	0.210	0.235	6	133	7x19	2973	4425	2.31	1500
1	259	7x37	0.210	0.235	5	133	7x19	3832	5703	2.40	1900
1/0	266	19x14	0.210	0.250	4	259	7x37	4410	6563	2.52	2400
2/0	342	19x18	0.210	0.250	3	259	7x37	4830	7188	2.60	3000
3/0	418	19x22	0.210	0.265	2	259	7x37	5695	8476	2.79	3800
4/0	532	19x28	0.210	0.265	1	259	7x37	6381	9497	2.90	4800
250*	627	19x33	0.210	0.265	1/0	266	19x14	7260	10806	3.05	5800
350*	888	37x24	0.210	0.280	2/0	342	19x18	8861	13188	3.31	7900
500*	1221	37x33	0.210	0.295	4/0	532	19x28	11590	17250	3.72	11400

* Based on ICEA S-75-381 NEMA WC 58

SHD-GC 15 kV

Electrical parameters

Power-grounding conductor size	Power conductor resistance at 25°C	Grounding conductor resistance at 25°C	Ground-check conductor resistance at 25°C	Inductance per unit length	Operating capacitance per unit length	Permissible short-circuit current **, **	Ampacity * 40°C ambient temperature
AWG or MCM	Ω/1000 ft	Ω/1000 ft	Ω/1000 ft	mH/1000 ft	μF/1000 ft	kA	A
2	0.172	0.436	0.679	0.131	0.07	4.80	164
1	0.137	0.349	0.679	0.126	0.07	6.06	187
1/0	0.109	0.274	0.679	0.122	0.08	7.65	215
2/0	0.0868	0.227	0.679	0.115	0.09	9.64	246
3/0	0.0688	0.172	0.679	0.114	0.09	12.15	283
4/0	0.0546	0.137	0.679	0.109	0.10	15.30	325
250	0.0466	0.109	0.436	0.101	0.12	18.16	355
350	0.0333	0.0868	0.436	0.096	0.13	25.31	435
500	0.0233	0.0546	0.436	0.091	0.16	36.18	536

* Ampacity - based on continuous duty at 90°C conductor temperature

** Short-circuit current - based on conductor temperature from 90°C up to 250°C

SHD-GC 25 kV											
Selection data											
Power conductor size	Power conductor stranding		Nominal thickness of insulation	Jacket thickness	Grounding conductor			Approximate weight		Approximate overall diameter	Maximum permissible tensile force
					Size	Stranding					
AWG or MCM			Inches	Inches	AWG			lbs./1000 ft	kg/km	Inches	N
2 AWG	259	7x37	0.295	0.235	6	133	7x19	4042	6016	2.55	1500
1 AWG	259	7x37	0.295	0.265	5	133	7x19	5170	7695	2.86	1900
1/0 AWG	266	19x14	0.295	0.265	4	259	7x37	5314	7910	2.91	2400
2/0 AWG	342	19x18	0.295	0.280	3	259	7x37	6171	9185	3.06	3000
3/0 AWG	418	19x22	0.295	0.280	2	259	7x37	6819	10149	3.19	3800
4/0 AWG	532	19x28	0.295	0.295	1	259	7x37	7779	11578	3.34	4800
250 MCM*	627	19x33	0.295	0.295	1/0	266	19x14	8543	12716	3.43	5800
350 MCM*	888	37x24	0.295	0.295	2/0	342	19x18	10269	15284	3.66	7900

SHD-GC 25 kV							
Electrical parameters							
Power-grounding conductor size	Power conductor resistance at 25°C	Grounding conductor resistance at 25°C	Ground-check conductor resistance at 25°C	Inductance per unit length	Operating capacitance per unit length	Permissible short-circuit current *, **	Ampacity * 40°C ambient temperature
AWG or MCM	Ω/1000 ft	Ω/1000 ft	Ω/1000 ft	mH/1000 ft	μF/1000 ft	kA	A
2 AWG	0.172	0.436	0.679	0.142	0.05	4.80	178
1 AWG	0.137	0.349	0.679	0.137	0.06	6.06	191
1/0 AWG	0.109	0.274	0.679	0.132	0.06	7.65	218
2/0 AWG	0.0868	0.227	0.679	0.125	0.07	9.64	249
3/0 AWG	0.0688	0.172	0.679	0.124	0.07	12.15	286
4/0 AWG	0.0546	0.137	0.679	0.118	0.08	15.30	327
250 MCM	0.0466	0.109	0.679	0.115	0.08	18.10	360
350 MCM	0.0333	0.087	0.679	0.107	0.10	25.31	435

* Ampacity - based on continuous duty at 90°C conductor temperature

** Short-circuit current - based on conductor temperature from 90°C up to 250°C

STANDARD PRINT LEGEND:

TF CABLE (VOLTAGE) (SIZE) TYPE SHD-GC FT1 FT5 (-50°C) +90°C P-07-KA060012-MSHA

SPECIAL FACTORY OPTIONS

Jacket: Red, yellow, green orange, blue

MSHA: P-7K268101 (CPE)

Jacket: TPU Red, yellow, green orange, blue

MSHA: P-07-KA030001 (TPU)

SHD-CGC FOM 5 kV



Round portable power cable with fibre optic modulus - mining grade	
Standards: ICEA S-75-381/NEMA WC-58	
CONSTRUCTION	
Conductors	Annealed flexible stranded tin coated copper in accordance with ASTM B 172 and ICEA S-75-381, Tab. 3-22
Conductor shield	Semi-conductive layer over the conductor. ICEA S-75-381 sec. 3.14
Insulation	Ethylene-propylene rubber (EPR)
Insulation shield	None - conducting bedding tape + Composite tinned copper/polyamide braid. Covering minimum 60%
Circuit identification	The polyamide in the shielding braid is coloured black, white, red in accordance with ICEA S-75-381
Grounding	Annealed tin coated copper acc. Tab. 3-25 of ICEA S-75-381
Fibre Optic Modulus (FOM): Identification of the fibres Fibre Fibre covering Core arrangement Sheath over the laid up cores	1x6G62.5/125 A-D(ZN)13Y or 2x6G62.5/125 Color coding of the fibres and buffering tubes 50 or 62.5 µm can be provided ,Diameter over cladding 125 µm Buffering tube with filling compound Two earth conductor and one fibre-optic element interstitial Special material. If needed over sheath the wrap synthetic tape
Assembly	Three power, FOM, two bare grounding cabled together on insulated Ground Check conductor in centre
Separator	A single faced rubber filled binder tape applied over core
Outer jacket	Black, extra heavy duty, high torsion resistant, integral-filled, reinforced poly-chloroprene thermosetting jacket, ICEA S-75-381 Tab. 3-3, 3-22, Sec.3.21. TPU optional jacket available
Colour of outer jacket	Black or colours can be provided
Minimum bending radius	8 x overall diameter of the cable
CHARACTERISTICS	
Excellent flexibility	
Highly ozone, sun, weather and flame resistant	
Rated and flexible at -40°C. In black poly-chloroprene and all colours TPU jackets suitable for -50°C	
Excellent impact and abrasion resistant	
Oil and heat resistant	
Indent printed for easy identification	
Application	For very heavy stresses as required for mines, Shaft sinking, Harbors, Steel mills, Quarries and Oil rigs
Standard length cable packing	1000 ft on drums. Other forms of packing and delivery are available on request

Power conductor size	Power conductor stranding		Nominal thickness of insulation	Jacket thickness	Grounding conductor			Approximate weight		Approximate overall diameter	Maximum permissible tensile force
					Size	Stranding		lbs./1000 ft	kg/km		
AWG or MCM			Inches	Inches	AWG					Inches	N
6	133	7x19	0.110	0.185	10	49	7x7	1543	2296	1.51	600
4	259	7x37	0.110	0.185	8	133	7x19	1849	2752	1.60	950
2	259	7x37	0.110	0.205	6	133	7x19	2358	3509	1.79	1500
1	259	7x37	0.110	0.205	5	133	7x19	2430	3618	1.88	1900
1/0	266	19x14	0.110	0.220	4	259	7x37	3056	4549	2.08	2400
2/0	342	19x18	0.110	0.220	3	259	7x37	3689	5490	2.12	3000
3/0	418	19x22	0.110	0.235	2	259	7x37	4320	6443	2.26	3800
4/0	532	19x28	0.110	0.235	1	259	7x37	4699	6994	2.51	4800
250	627	19x33	0.120	0.250	1/0	266	19x14	5825	8670	2.57	5800
350	888	37x24	0.120	0.265	2/0	342	19x18	7414	11035	2.83	7900
500	1221	37x33	0.120	0.280	4/0	532	19x28	9602	14292	3.18	11400

* Based on ICEA S-75-381 NEMA WC 58

Power grounding conductor size	Power conductor resistance at 25°C	Grounding conductor resistance at 25°C	Inductance per unit length	Operating capacitance per unit length	Permissible short-circuit current **, ***	Ampacity * 40°C ambient temperature
AWG or MCM	Ω/1000 ft	Ω/1000 ft	mH/1000 ft	μF/1000 ft	kA	A
6 AWG	0.436	1.109	0.132	0.08	1.90	93
4 AWG	0.274	0.697	0.119	0.09	3.03	122
2 AWG	0.172	0.436	0.112	0.10	4.80	159
1 AWG	0.137	0.349	0.108	0.11	6.06	184
1/0 AWG	0.109	0.274	0.105	0.12	7.65	211
2/0 AWG	0.0868	0.227	0.099	0.14	9.64	243
3/0 AWG	0.0688	0.172	0.098	0.14	12.15	279
4/0 AWG	0.0546	0.137	0.094	0.16	15.30	321
250 MCM	0.0466	0.109	0.089	0.18	18.16	355
350 MCM	0.0333	0.0868	0.085	0.21	25.31	435
500 MCM	0.0233	0.0546	0.082	0.24	36.18	536

* Ampacity - based on continuous duty at 90°C conductor temperature

** Short-circuit current

*** Based on conductor temperature from 90°C up to 250°C

SHD-PCG 2 kV

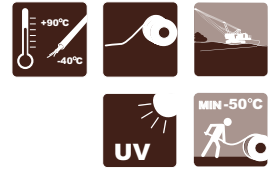
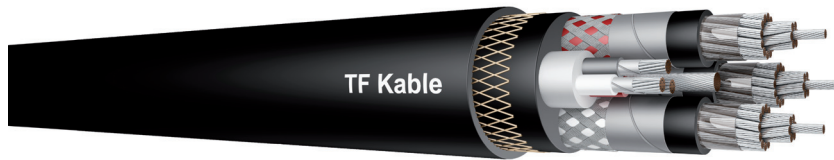

Round portable power cables, mining grade	
Standards: ICEA S-75-381/NEMA WC-58	
CONSTRUCTION	
Conductors	Annealed flexible stranded tin coated copper in accordance with ASTM B-33, ASTM B 172 or B 173
Separator	Polyester tape over the conductor
Insulation	Ethylene-propylene rubber (EPR)
Insulation shield	None - conducting bedding tape + Composite tinned copper/polyamide braid. Covering minimum 60%
Circuit identification	The polyamide in the shielding braid is coloured black, white, red in accordance with ICEA S-75-381
Grounding	Annealed tin coated copper, located in the centre of cable
Pilot group	Annealed tin coated copper, EPR insulation and overall thermosetting jacket. Colour of insulation: black, white red. Size 8 AWG and 6 AWG for power conductor 4/0 AWG and bigger sizes
Assembly	Three power and group of 3 pilot conductors cabled on none-insulated tinned ground conductor and a nylon open braid applied overall. Integral filled jacket for higher torsion resistance
Outer jacket	A reinforced extra heavy duty poly-chloroprene thermosetting compound
Colour of outer jacket	Black
CHARACTERISTICS	
Excellent flexibility	
Highly ozone, sun, weather and flame retardant	
Rated and flexible at -40°C to +90°C	
Excellent impact and abrasion resistant	
Oil and heat resistant	
Indent printed for easy identification	
Application	Designed for use on long wall shearers, drills, conveyors, pumps, and mobile equipment requiring grounding conductor, three insulated pilot cores and individual metallic shield over insulation of power cores Other industrial, mining applications
Standard length cable packing	1000 ft on drums. Other forms of packing and delivery are available on request
Approvals	MSHA: P-7K-254029-4

Power conductor size	Power conductor stranding	Nominal thickness of insulation	Jacket thickness	Grounding conductor			Approximate weight		Approximate overall diameter	Maximum permissible tensile force	
				Size	Stranding		lbs./1000 ft	kg/km			
AWG or MCM		Inches	Inches	AWG					Inches	N	
1/0	266	19x14	0.080	0.205	2	259	7x37	3264	4859	2.01	2400
2/0	342	19x18	0.080	0.220	2	259	7x37	3815	5678	2.15	3000
3/0	418	19x22	0.080	0.220	1	259	7x37	3933	5854	2.32	3825
4/0	532	19x28	0.080	0.250	1/0	266	19x14	5225	8224	2.54	4815
250	627	19x33	0.095	0.250	1/0	266	19x14	5644	8400	2.65	5800
300	740	37x20	0.095	0.250	1/0	266	19x14	6420	9555	2.70	6825
350	888	37x24	0.095	0.265	2/0	342	19x18	7089	10550	2.85	7900

Power grounding conductor size	Power conductor resistance at 25°C	Grounding conductor resistance at 25°C	Inductance per unit length	Operating capacitance per unit length	Permissible short-circuit current **, ***	Ampacity* 40°C ambient temperature
AWG or MCM	Ω/1000 ft	Ω/1000 ft	mH/1000 ft	μF/1000 ft	kA	A
1/0 - 2	0.109	0.172	0.096	0.16	7.65	211
2/0 - 2	0.0868	0.172	0.090	0.17	9.64	243
3/0 - 1	0.0688	0.137	0.087	0.20	12.16	279
4/0 - 1/0	0.0546	0.109	0.085	0.21	15.30	321
250 - 1/0	0.0466	0.109	0.081	0.21	18.60	355
300 - 1/0	0.0389	0.109	0.083	0.22	21.74	395
350 - 2/0	0.0333	0.0868	0.084	0.24	25.31	435

* Ampacity - based on continuous duty at 90°C conductor temperature

** Short-circuit current

*** Based on conductor temperature from 90°C up to 250°C

STANDARD PRINT LEGEND:

TF CABLE 2000V (SIZE) TYPE SHD-PCG P-7K-254029-4

SPECIAL FACTORY OPTIONS

Other available colours: Red, yellow, green orange, blue

SHD-PCG 5 kV

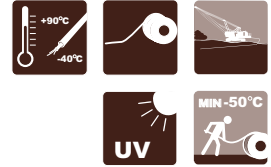
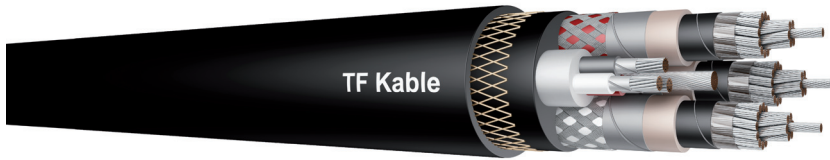

Round portable power cables, mining grade	
Standards: ICEA S-75-381/NEMA WC-58	
CONSTRUCTION	
Conductors	Annealed flexible stranded tin coated copper in accordance with ASTM B-33, ASTM B 172 or B 173
Separator	Semi-conducting layer between conductor and insulation
Insulation	Ethylene-propylene rubber (EPR)
Insulation shield	Synthetic bedding tape +Composite tinned copper/polyamide braid. Covering minimum 60%
Circuit identification	The polyamide in the shielding braid is coloured black, white, red in accordance with ICEA S-75-381
Grounding	Annealed tin coated copper, located in the centre of cable
Pilot group	Annealed tin coated copper, EPR insulation and overall thermosetting jacket. Colour of insulation: black, white red. Size 8 AWG and 6 AWG for power conductor 4/0 AWG and bigger sizes
Assembly	Three power and group of 3 pilot conductors cabled on none insulated tinned ground conductor and a nylon open braid applied overall. Integral filled jacket for higher torsion resistance
Outer jacket	A reinforced extra heavy duty poly-chloroprene thermosetting compound
Colour of outer jacket	Black
CHARACTERISTICS	
Excellent flexibility	
Highly ozone, sun, weather and flame retardant	
Rated and flexible at -40°C to +90°C	
Excellent impact and abrasion resistant	
Oil and heat resistant	
Indent printed for easy identification	
Application	Designed for use on long wall shearers, drills, conveyors, pumps, and mobile equipment requiring grounding conductor, three insulated pilot cores and individual metallic shield over insulation of power cores Other industrial, mining applications
Standard length cable packing	1000 ft on drums. Other forms of packing and delivery are available on request
Approvals	MSHA: P-7K-254029-4

Power conductor size	Power conductor stranding		Nominal thickness of insulation	Jacket thickness	Grounding conductor			Approximate weight		Approximate overall diameter	Maximum permissible tensile force
					Size	Stranding		lbs./1000 ft	kg/km		
AWG or MCM			Inches	Inches	AWG					Inches	N
1/0	266	19x14	0.110	0.220	1	259	7x37	3800	5654	2.27	2400
2/0	342	19x18	0.110	0.220	2	259	7x37	4100	6100	2.43	3000
3/0	418	19x22	0.110	0.235	1	259	7x37	5000	7440	2.57	3825
4/0	532	19x28	0.110	0.250	1/0	266	19x14	6000	8928	2.75	4815
250	627	19x33	0.120	0.250	1/0	266	19x14	6132	9127	2.88	5800
350	888	37x24	0.120	0.265	2/0	342	19x18	7564	11258	3.12	7900

Power grounding conductor size	Power conductor resistance at 25°C	Grounding conductor resistance at 25°C	Inductance per unit length	Operating capacitance per unit length	Permissible short-circuit current **, ***	Ampacity * 40°C ambient temperature
AWG or MCM	Ω/1000 ft	Ω/1000 ft	mH/1000 ft	μF/1000 ft	kA	A
1/0 - 2	0.109	0.137	0.097	0.13	7.65	211
2/0 - 2	0.0868	0.172	0.096	0.13	9.64	243
3/0 - 1	0.0688	0.137	0.092	0.15	12.16	279
4/0 - 1/0	0.0546	0.109	0.090	0.16	15.30	321
250 - 1/0	0.0466	0.109	0.089	0.18	18.16	355
350 - 2/0	0.0333	0.0868	0.085	0.21	25.31	435

* Ampacity - based on continuous duty at 90°C conductor temperature

** Short-circuit current

*** Based on conductor temperature from 90°C up to 250°C

STANDARD PRINT LEGEND:

TF CABLE 5000V (SIZE) TYPE SHD-PCG P-7K-254029-4

SPECIAL FACTORY OPTIONS

Other available colours: Red, yellow, green orange, blue

Efficient
and reliable



SHD-PCG 8 kV

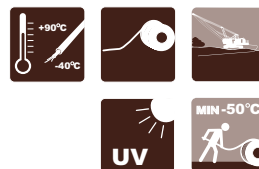
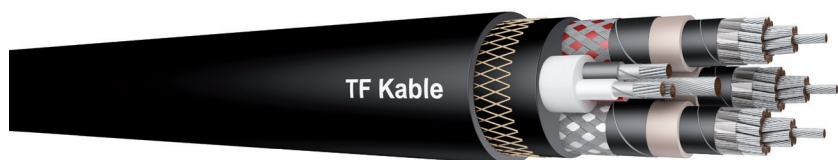

Round portable power cables, mining grade	
Standards: ICEA S-75-381/NEMA WC-58	
CONSTRUCTION	
Conductors	Annealed flexible stranded tin coated copper in accordance with ASTM B-33, ASTM B 172 or B 173
Separator	Semi-conducting layer between conductor and insulation
Insulation	Ethylene-propylene rubber (EPR)
Insulation shield	Semi-conducting bedding tape +Composite tinned copper/polyamide braid. Covering minimum 60%
Circuit identification	The polyamide in the shielding braid is coloured black, white, red in accordance with ICEA S-75-381
Grounding	Annealed tin coated copper, located in the centre of cable
Pilot group	Annealed tin coated copper, EPR insulation and overall thermosetting jacket. Colour of insulation: black, white red. Size 8 AWG and 6 AWG for power conductor 4/0 AWG and bigger sizes
Assembly	Three power and group of 3 pilot conductors cabled on bare tinned ground conductor and a nylon open braid applied overall. Integral filled jacket for higher torsion resistance
Outer jacket	A reinforced extra heavy duty poly-chloroprene thermosetting compound
Colour of outer jacket	Black
CHARACTERISTICS	
Excellent flexibility	
Highly ozone, sun, weather and flame retardant	
Rated and flexible at -40°C to +90°C	
Excellent impact and abrasion resistant	
Oil and heat resistant	
Indent printed for easy identification	
Application	Designed for use on long wall shearers, drills, conveyors, pumps, and mobile equipment requiring grounding conductor, three insulated pilot cores and individual metallic shield over insulation of power cores Other industrial, mining applications
Standard length cable packing	1000 ft on drums. Other forms of packing and delivery are available on request
Approvals	MSHA: P-7K-254029-4

Power conductor size	Power conductor stranding		Nominal thickness of insulation	Jacket thickness	Grounding conductor			Approximate weight		Approximate overall diameter	Maximum permissible tensile force
					Size	Stranding					
AWG or MCM			Inches	Inches	AWG			lbs./1000 ft	kg/km	Inches	N
1/0	266	19x14	0.150	0.220	1	259	7x37	4000	5952	2.38	2400
2/0	342	19x18	0.150	0.235	1	259	7x37	4510	6712	2.46	3000
3/0	418	19x22	0.150	0.250	1	259	7x37	5200	7738	2.66	3825
4/0	532	19x28	0.150	0.250	1/0	266	19x14	6500	9672	2.79	4815
250	627	19x33	0.150	0.250	1/0	266	19x14	6612	9841	3.02	5800
350	888	37x24	0.150	0.280	2/0	342	19x18	8062	12000	3.34	7900

Power grounding conductor size	Power conductor resistance at 25°C	Grounding conductor resistance at 25°C	Inductance per unit length	Operating capacitance per unit length	Permissible short-circuit current **, ***	Ampacity * 40°C ambient temperature
AWG or MCM	Ω/1000 ft	Ω/1000 ft	mH/1000 ft	μF/1000 ft	kA	A
1/0 - 2	0.109	0.137	0.097	0.13	7.65	211
2/0 - 2	0.0868	0.172	0.096	0.13	9.64	243
3/0 - 1	0.0688	0.137	0.092	0.15	12.16	279
4/0 - 1/0	0.0546	0.109	0.090	0.16	15.30	321
250 - 1/0	0.0466	0.109	0.089	0.18	18.16	355
350 - 2/0	0.0333	0.0868	0.085	0.21	25.31	435

* Ampacity - based on continuous duty at 90°C conductor temperature

** Short-circuit current

*** Based on conductor temperature from 90°C up to 250°C

STANDARD PRINT LEGEND:

TF CABLE 8000V (SIZE) TYPE SHD-PCG P-7K-254029-4

SPECIAL FACTORY OPTIONS

Other available colours: Red, yellow, green orange, blue

MP-GC 5, 8, 15, 25 kV EPR/CPE



Mine power feeder cable extra heavy duty EPR/CPE 90°C MSHA Mining grade	
Standards: ICEA S-75-381/NEMA WC-58, ASTM B-8	
CONSTRUCTION	
Conductors	Bare copper concentric strand in accordance with ASTM B 8
Conductor shield	Semi-conductive tape and layer over the conductor. ICEA S-75-381 sec. 3.14
Insulation	Ethylene-propylene rubber (EPR). ICEA S-75-381 Tab. 4-2
Insulation shield	Semi-conducting compound as per 4.5 of ICEA S-75-381 and 0.005" copper tape
Circuit identification	The polyamide in the shielding braid is coloured black, white, red in accordance with ICEA S-75-381
Grounding	Annealed tin coated copper Class B comply with Tab. 4-1 of ICEA S-75-381
Ground check	Bare copper conductor. ICEA S-75-381 Tab. 4-1. Insulation color: yellow
Assembly	Three power, the ground check, two tinned copper grounding conductors cabled with cured rubber fillers as required to make an essentially round core
Separator	A single faced rubber filled binder tape applied over core
Outer jacket	A CPE thermosetting compound, extra heavy duty as per Table 3-3, sec. 3.21
Colour of outer jacket	Black or other colours can be provided
Colour mode	Colour thread: black, red white applied under metallic shielding tape. ICEA S-75-381 sec.4.6
CHARACTERISTICS	
Ozone, sun, weather and flame resistant	
Oil and heat resistant	
Maximum continuous conductor temperature: 90°C	
Ink jet printed for easy identification	
Application	For use as trailing mining cables For use from 5 kV up to 25 kV when installed in ducts, conduit, open air and direct burial in wet and dry locations Other industrial, mining applications
Standard length cable packing	1000 ft on drums. Other forms of packing and delivery are available on request
Approvals	MSHA:P-07-KA050003-1

Power conductor size	Power conductor stranding	Size		Nominal insulation thickness	Nominal jacket thickness	Nominal O.D.		Approximate O.D.		Maximum permissible tensile force
		Ground	Ground check			Inches	mm	Lbs/1000ft	kg/km	
AWG or MCM	No. of wires	AWG	AWG							
Type MP-GC-5000 volts-100% insulation level										
4	7	8	8	0.09	0.110	1.32	33.5	1210	1800	950
2	7	6	8	0.09	0.110	1.45	36.8	1650	2455	1500
1	19	5	8	0.09	0.110	1.63	38.9	2023	3012	1900
1/0	19	4	8	0.09	0.110	1.68	42.7	2583	3845	2400
2/0	19	3	8	0.09	0.140	1.74	44.2	2700	4018	3000
4/0	37	1	8	0.09	0.140	2.00	50.8	3900	5803	4800
250	37	1/0	8	0.09	0.140	2.13	54.1	4600	6840	5800
350	37	2/0	8	0.09	0.140	2.35	59.7	5900	8780	7900
500	37	4/0	8	0.09	0.140	2.64	67.1	8150	12100	11400
Type MP-GC-8000 volts-100% insulation level										
4	7	8	8	0.115	0.110	1.43	36.3	1410	2042	950
2	7	6	8	0.115	0.110	1.55	39.4	1750	2604	1500
1	19	5	8	0.115	0.110	1.65	41.9	2050	3051	1900
1/0	19	4	8	0.115	0.140	1.75	44.5	2410	3587	2400
2/0	19	3	8	0.115	0.140	1.88	47.8	2900	4316	3000
4/0	37	1	8	0.115	0.140	2.12	53.8	4100	6102	4800
250	37	1/0	8	0.115	0.140	2.25	57.2	4720	7024	5800
350	37	2/0	8	0.115	0.140	2.46	62.5	6070	9030	7900
Type MP-GC-15000 volts-100% insulation level										
2	7	6	8	0.175	0.140	1.88	47.8	2285	3400	1500
1	19	5	8	0.175	0.140	1.98	50.3	2465	3668	1900
1/0	19	4	8	0.175	0.140	2.05	52.1	2785	4145	2400
2/0	19	3	8	0.175	0.140	2.15	54.6	3295	4904	3000
4/0	37	1	8	0.175	0.140	2.40	61.0	4605	6853	4800
250	37	1/0	8	0.175	0.140	2.50	63.5	4980	7400	5800
350	37	2/0	8	0.175	0.140	2.75	69.9	6370	9478	7900
500	37	4/0	8	0.175	0.140	3.10	78.7	8760	13030	11400
Type MP-GC-25000 volts-100% insulation level										
6	7	10	10	0.260	0.140	2.087	53.0	3504	5215	93
4	7	8	8	0.260	0.140	2.205	56.0	3914	5825	122
2	7	6	8	0.260	0.170	2.339	59.4	2956	4400	178
1	19	5	8	0.260	0.170	2.421	61.5	3763	5600	191
1/0	19	4	8	0.260	0.170	2.508	63.7	4636	6900	218
2/0	19	3	8	0.260	0.170	2.602	66.1	5039	7500	249
3/0	19	2	8	0.260	0.170	2.713	68.9	5711	8500	285
4/0	19	1	8	0.260	0.170	2.894	73.5	6383	9500	327
250	19	1/0	8	0.260	0.170	2.992	76.0	7055	10500	360
350	37	2/0	8	0.260	0.170	3.217	81.7	9071	13500	435

Power grounding conductor size	Power conductor resistance at 25°C	Grounding conductor resistance at 25°C	Ground-check conductor resistance at 25°C	Inductance per unit length	Operating capacitance per unit length	Permissible short-circuit current **, **	Ampacity * 40°C ambient temperature
AWG or MCM	Ω/1000 ft	Ω/1000 ft	Ω/1000 ft	mH/1000 ft	μF/1000 ft	kA	A
MP-GC-5000 volts-100% insulation level							
4 AWG	0.258	0.678	0.652	0.117	0.09	3.03	122
2 AWG	0.162	0.427	0.652	0.111	0.10	4.80	159
1 AWG	0.129	0.338	0.652	0.107	0.11	6.06	184
1/0 AWG	0.102	0.269	0.652	0.104	0.12	7.65	211
2/0 AWG	0.081	0.213	0.652	0.098	0.14	9.64	243
4/0 AWG	0.051	0.134	0.652	0.093	0.16	15.30	321
250 MCM	0.043	0.102	0.652	0.087	0.20	18.16	355
350 MCM	0.031	0.081	0.652	0.083	0.22	25.31	435
500 MCM	0.022	0.051	0.652	0.080	0.26	36.18	536
Type MP-GC-8000 volts-100% insulation level							
4 AWG	0.258	0.678	0.652	0.117	0.09	3.03	122
2 AWG	0.162	0.427	0.652	0.111	0.10	4.80	159
1 AWG	0.129	0.338	0.652	0.107	0.11	6.06	184
1/0 AWG	0.102	0.269	0.652	0.104	0.12	7.65	211
2/0 AWG	0.081	0.213	0.652	0.098	0.14	9.64	243
4/0 AWG	0.051	0.134	0.652	0.093	0.16	15.30	321
250 MCM	0.043	0.102	0.652	0.087	0.20	18.16	355
350 MCM	0.031	0.081	0.652	0.083	0.22	25.31	435
500 MCM	0.022	0.051	0.652	0.080	0.26	36.18	536
Type MP-GC-15000, 25000 volts-100% insulation level							
2 AWG	0.162	0.427	0.652	0.122	0.08	4.80	164
1 AWG	0.129	0.338	0.652	0.118	0.08	6.06	187
1/0 AWG	0.102	0.269	0.652	0.114	0.09	7.65	215
2/0 AWG	0.081	0.213	0.652	0.107	0.10	9.64	246
4/0 AWG	0.051	0.134	0.652	0.102	0.11	15.30	325
250 MCM	0.043	0.102	0.652	0.094	0.14	18.16	355
350 MCM	0.031	0.081	0.652	0.090	0.16	25.31	435
500 MCM	0.022	0.051	0.652	0.086	0.18	36.18	536

* Ampacity-based on continuous duty at 90°C conductor temperature
** Short-circuit current - based on conductor temperature from 90°C up to 250°C

TYPE W, 1 to 5 cores 2000 V

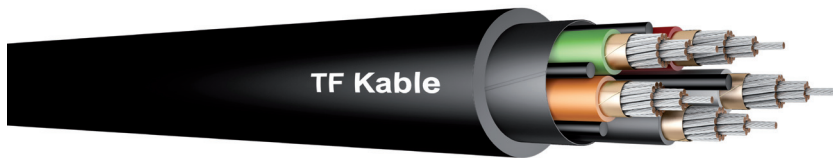

Portable Power Cables 90°C UL C (UL) MSHA	
Standards: ICEA S-75-381/NEMA WC-58, ICEA S-95-658/NEMA, WC70, ASTM 172, ASTM B-33, UL 44	
CONSTRUCTION	
Conductors	Annealed flexible stranded tinned copper ASTM B 172 and ICEA S-75-381/NEMA WC58
Separator	If needed tape separator between conductor and insulation. ICEA S-75-381
Insulation	Ethylene-propylene rubber (EPR). ICEA S-75-381, sec 3.21, Tab. 3-6
Circuit identification	In accordance with ICEA S-75-381, sec. 3.18
2-cores	Black, white
3-cores	Black, white, green
4-cores	Black, white, green, red
5-cores	Black, white, green, red, orange
Reinforcement	Single faced rubber filled binder tape over insulation for single core Single faced rubber filled binder tape over core of cable for multi-core types W
Jacket	Black heavy duty CPE thermosetting compound, ICEA S-75-381, sec. 3.21 Tab. 3-4
Bending radius	Minimum 6 x outer diameter
CHARACTERISTICS	
Super-Excellent flexibility	
Water resistant and flame retardant	
Rated and flexible at -40°C to +90°C	
Excellent impact and abrasion resistant	
Ozone, sunlight, oil, grease, weather, chemical and heat resistant	
Application	Portable power systems Other industrial applications
Standard length cable packing	1000 ft on drums. Other forms of packing and delivery are available on request
Approvals	UL: E207132 – Oil Resistant Oil Resistant Inners, Sunlight resistant 90 C Wet or Dry, MSHA: P-7K-268101 C(UL) E207132, FT1 ,FT5 -40°C to +90°C

Size	Conductor stranding		Nominal insulation thickness		Approximate overall diameter		Approximate weight		Ampacity * 40°C ambient temperature
			Inches	mm	Inches	mm	lbs. per	kg/km	
AWG or MCM									
W 1-core									
8	199	7x19	0.06	1.52	0.440	11.2	129	192	83
6	133	7x19	0.06	1.52	0.511	13.0	188	280	109
4	259	7x37	0.06	1.52	0.551	14.0	249	371	145
2	259	7x37	0.06	1.52	0.638	16.2	363	540	192
1	259	7x37	0.08	2.03	0.720	18.3	439	654	223
1/0	266	19x14	0.08	2.03	0.768	19.5	526	783	258
2/0	342	19x18	0.08	2.03	0.787	20.0	625	930	298
3/0	418	19x22	0.08	2.03	0.870	22.1	757	1126	345
4/0	532	19x28	0.08	2.03	0.885	22.5	897	1335	400
250	627	19x33	0.095	2.41	1.031	26.2	1088	1619	445
350	888	37x24	0.095	2.41	1.146	29.1	1444	2149	552
500	1221	37x33	0.095	2.41	1.255	31.9	1913	2846	695
750	1769	61x29	0.110	2.79	1.579	40.1	2916	4341	898
800	1891	61x31	0.110	2.79	1.614	41.0	3071	4570	925
W 2-core									
8	133	7x19	0.06	1.52	0.83	21.1	391	581	72
6	133	7x19	0.06	1.52	0.94	23.9	571	849	95
4	259	7x37	0.06	1.52	1.07	27.3	793	1180	127
2	259	7x37	0.06	1.52	1.26	32.1	1142	1699	167
1	259	7x37	0.08	2.03	1.41	35.9	1357	2019	191
1/0	266	19x14	0.08	2.03	1.51	38.3	1693	2520	217
2/0	342	19x18	0.08	2.03	1.65	41.9	1908	2840	250
3/0	418	19x22	0.08	2.03	1.77	45.0	2600	3870	286
4/0	532	19x28	0.08	2.03	1.92	48.8	2675	3980	328
250	627	19x33	0.095	2.41	2.10	53.3	3434	5110	363
W 3-core									
8	133	7x19	0.06	1.52	0.91	23.1	541	805	59
6	133	7x19	0.06	1.52	1.01	25.7	715	1064	79
4	259	7x37	0.06	1.52	1.05	26.5	1010	1503	104
2	259	7x37	0.06	1.52	1.32	33.6	1405	2091	138
1	259	7x37	0.08	2.03	1.51	38.4	1734	2581	161
1/0	266	19x14	0.08	2.03	1.63	41.4	2030	3010	186
2/0	342	19x18	0.08	2.03	1.73	44.0	2566	3818	215
3/0	418	19x22	0.08	2.03	1.85	47.0	2885	4293	249
4/0	532	19x18	0.08	2.03	1.99	50.6	3479	5177	287
250	627	19x33	0.095	2.41	2.39	60.7	4368	6500	320
350	888	37x24	0.095	2.41	2.66	67.5	5895	8772	394
500	1221	37x33	0.095	2.41	2.98	75.8	7820	11638	487
W 4-core									
8	133	7x19	0.06	1.52	0.97	24.6	656	976	54
6	133	7x19	0.06	1.52	1.11	28.3	908	1352	72

Size	Conductor stranding		Nominal insulation thickness		Approximate overall diameter		Approximate weight		Ampacity* 40°C ambient temperature
			Inches	mm	Inches	mm	lbs. per	kg/km	
AWG or MCM									A
4	259	7x37	0.06	1.52	1.26	32.1	1262	1878	93
2	259	7x37	0.06	1.52	1.43	36.3	1759	2618	122
1	259	7x37	0.08	2.03	1.71	43.4	2322	3456	143
1/0	266	19x14	0.08	2.03	1.78	45.2	2721	4050	165
2/0	342	19x18	0.08	2.03	1.89	48.0	3293	4901	192
3/0	418	19x22	0.08	2.03	2.02	51.4	3849	5729	221
4/0	532	19x18	0.08	2.03	2.22	56.3	4765	7092	255
250	627	19x33	0.095	2.41	2.61	66.2	5579	8303	280
350	888	37x24	0.095	2.41	2.92	74.2	7329	10908	335
500	1221	37x33	0.095	2.41	3.36	85.3	9896	14729	395
W 5-core									
10 AWG **	49	7x7	0.06	1.52	0.93	23.7	568	837	35
8 AWG	133	7x19	0.06	1.52	1.07	27.2	776	1154	50
6 AWG	133	7x19	0.06	1.52	1.24	31.5	1024	1524	68
4 AWG	259	7x37	0.06	1.52	1.36	35.2	1432	2131	88
2 AWG	259	7x37	0.06	1.52	1.56	39.8	2051	3052	116
1 AWG	259	7x37	0.06	1.52	1.85	47.1	2665	3967	136
1/0 AWG	266	19x14	0.08	2.03	1.98	50.4	3406	5069	150
2/0 AWG	342	19x18	0.08	2.03	2.13	54.1	3596	5351	172
3/0 AWG	418	19x22	0.08	2.03	2.27	57.6	4728	7035	200
4/0 AWG	532	19x28	0.08	2.03	2.46	62.6	5512	8203	230
250 MCM **	627	19x33	0.095	2.41	2.72	69.0	6333	9425	256
500 MCM **	1221	37x33	0.095	2.41	3.50	88.9	-	17300	395

* Ampacity - based on 90°C conductor temperature
** Based on ICEA S-75-381/NEMA WC-58, without approvals



Transforming the future mine



SOUTH AFRICAN STANDARDS SANS

TYPE 41 640/1100 V	110
TYPE 63 1.9/3.3 kV	112
TYPE 66, 66ECC 3.8/6.6 kV	114
TYPE 611, 611ECC 6.35/11 kV	116
TYPE 622, 622ECC 12.7/22 kV	118
TYPE 633, 633ECC 19/33 kV	120
MINING FLEXIBLE CABLE 640/1100 V	122



TYPE 41 640/1100 V

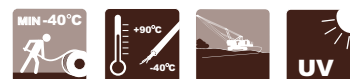
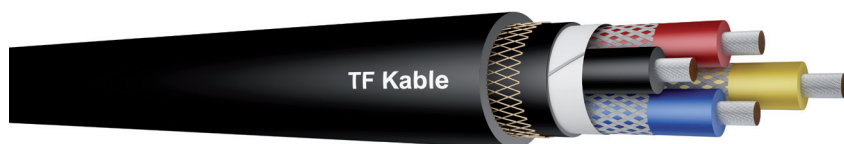

Flexible scoop cable	
Standards: SANS 1520-1	
CONSTRUCTION	
Conductors	Flexible class 5 comply to SANS 1411 - 1 from tinned annealed copper wires left lay
Insulation	Ethylene propylene thermosetting compound type RD 3 comply to SANS 1411-3
Core of cable	Three tinned copper/nylon braid screened power cores and one unscreened pilot core laid up in the right hand lay around rubber (RD1) filler centre
Inner sheath	Poly-chloroprene thermosetting compound type RS 6 comply to SANS 1411-3
Re-enforcement	An open nylon braid. Minimum 16 of nylon strings
Outer sheath	Poly-chloroprene thermosetting compound type RS 6 comply to SANS 1411-3. Inner and outer sheath are bonded to provide proper torsional protection, black
Standard marking	TF KABLE 3 Type 41 (Size) (Voltage) (Year)
CHARACTERISTICS	
Excellent flexibility	
Minimum ambient temperature -25°C, maximum conductor temperature 90°C	
Marking for easy identification	
Application	Electrically driven machines, movable electric apparatus in hazardous areas. For small pumps, fans, drills 2.5 mm ² . For shuttle cars 16 mm ² . Types 16, 25 mm ² suitable for reeling
Standard length cable packing	1000 m on drums. Other forms of packing and delivery are available on request

Power cores						Pilot cores			Lay ratio	Approx. cable dia.	Cable mass	Min. bending radius	Max. recommended tension
Conductor size	Max. wire dia.	Approx. wire dia.	Max. screen wire dia.	Braided screen filling factor	Approx. summarized screen filling factor	Conductor sizes	Max. wire dia.	Approx. conductor dia.					
mm ²	mm	mm	mm	%	mm ²	mm ²	mm	mm	x PCD	mm	kg/km	mm	kN
2.5	0.26	2.1	0.21	80	8	2.5	0.26	2.1	8	20	0.712	120	0.15
4	0.31	2.7	0.21	80	9.5	4	0.31	2.7	8	25	0.902	150	0.24
6	0.31	3.3	0.21	80	10.4	6	0.31	3.3	8	26	1.103	160	0.36
10	0.41	4.2	0.31	80	19	10	0.41	4.2	8	29	1.563	180	0.60
16	0.41	5.3	0.31	80	22	16	0.41	5.3	8	33	2.105	200	0.95
25	0.41	6.8	0.31	80	25	16	0.41	5.3	8	39	2.705	240	1.1

Power cores				Current rating at 30°C ambient				Short circuit rating	
Max. conductor DC resistance at 20°C	Max. conductor DC resistance at 90°C	Reactance	Impedance (Z) at 30°C	Laid out straight	1 layer on drum	2 layers on drum	3 layers on drum	Symmetrical fault current	Earth fault current (screens)
Ω/km	Ω/km	Ω/km	Ω/km	A	A	A	A	kA for 1s	kA for 1s
5.50	7.01	0.123	7.01	45	38	29	20	0.49	0.5
3.66	4.67	0.115	4.67	57	48	37	25	0.73	0.7
2.11	2.69	0.108	2.69	77	65	50	34	1.2	0.6
1.34	1.71	0.103	1.71	100	85	65	45	2.0	1.0
0.859	1.10	0.100	1.10	130	110	84	58	3.1	1.6

TYPE 63 1.9/3.3 kV

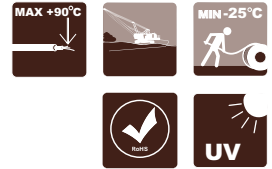
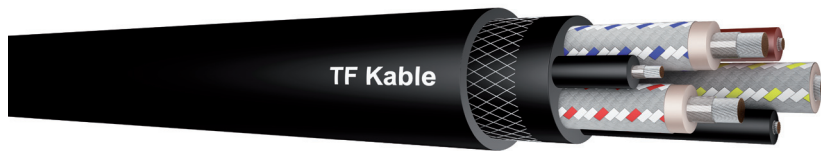

Flexible copper screened mining cables	
Standards: SANS 1520-2	
CONSTRUCTION	
Conductors	Flexible class 5 comply to SANS 1411-1 from tinned annealed copper wires left lay
Insulation	Ethylene propylene thermosetting compound type RD 3 comply to SANS 1411-3
Insulation screen	The braid of tinned copper wires
Cable assembly	Three tinned copper braided screened power cores and three unscreened pilot cores one in each interstice laid up in the right hand lay around semi-conductive cradle centre
Internal sheath	Poly-chloroprene thermosetting compound type RS 6 comply to SANS 1411-3
Reinforcing braid	An open nylon braid. Minimum 16 of nylon strings
Outer sheath	Poly-chloroprene thermosetting compound type RS 6 comply to SANS 1411-3. Inner and outer sheath are bonded to provide proper torsional protection, black
Physical properties	As per Table 1
Electrical properties	As per Table 2
Standard marking	TF KABLE 3 Type 63 (Size) (Year). Legible and indelible ink jet or embossing (for 25 mm ² and larger) as per order
CHARACTERISTICS	
Excellent flexibility	
Abrasion, tear resistant and flame retardant	
Temperature range: minimum ambient temperature is -25°C. Maximum conductor temperature is +90°C	
UV, sunlight, ozone and oil resistant	
Application	Electrically driven machines, movable electric apparatus in hazardous areas. Stackers, shearers, conveyor systems. Suitable for reeling purposes Other industrial applications
Standard length cable packing	500 m on drums. Other forms of packing and delivery are available on request

Table 1

Physical properties									
Power cores									
Conductor sizes (mm ²)	25	35	50*	70	95	120	150	185	240
Maximum wire diameter (mm)	0.41	0.41	0.41	0.51	0.51	0.51	0.51	0.51	0.51
Approximate conductor diameter (mm)	6.8	8.5	10.3	11.9	13.5	15.5	17.3	20.2	22.9
Maximum screen wire diameter (mm)	0.31	0.31	0.31	0.31	0.31	0.31	0.31	0.31	0.31
Braided screen filling factor (%)	80	80	80	80	80	80	80	80	80
Approximate summarized screen cross-section for power cores - weighing method (mm ²)	31	33	38	42	47	50	55	60	64
Pilot cores									
Conductor sizes (mm ²)	10	10	10	16	16	16	25	25	25
Maximum wire diameter (mm)	0.41	0.41	0.41	0.41	0.41	0.41	0.41	0.41	0.41
Approximate conductor diameter (mm)	4.2	4.2	5.3	5.3	5.3	5.3	6.8	6.8	6.8
Lay ratio (maximum) (x PCD)	8	8	8	8	8	8	8	8	8
Cable diameter									
Approximately (mm)	44	48	50.5	56	61	63	66	72	78
Cable mass - approximately (kg/m)	3.6	4.2	4.2	6.4	7.7	8.5	10.5	11.4	14.0
Minimum bending radius (mm)	280	290	310	350	370	380	400	440	480
Maximum recommended tension (kN)	1.1	1.6	2.3	3.2	4.3	5.4	6.8	8.3	10.8

Table 2

Electrical properties									
Power cores									
Maximum cond. DC resistance at 20°C (Ω/km)	0.859	0.610	0.424	0.299	0.227	0.177	0.143	0.117	0.0882
Maximum cond. DC resistance at 90°C (Ω/km)	1.10	0.778	0.542	0.382	0.290	0.227	0.183	0.150	0.115
Reactance (Ω/km)	0.122	0.113	0.107	0.103	0.090	0.088	0.085	0.084	0.083
Impedance (Z) at 90°C (Ω/km)	1.11	0.786	0.552	0.396	0.304	0.243	0.202	0.172	0.142
Sustained current rating at 30°C ambient									
Laid out straight (A)	130	160	200	245	295	345	390	440	520
Short circuit rating									
Symmetrical fault current (kA for 1 sec)	3.1	4.3	6.1	8.5	11.6	14.6	18.3	23	29
Earth fault current - screens (kA for 1 sec)	1.6	2.1	3.1	3.5	4.1	4.1	4.1	4.1	4.1

TYPE 66, 66ECC 3.8/6.6 kV

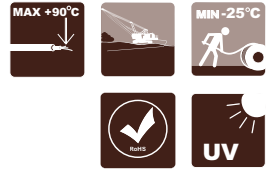

Flexible copper screened mining cables	
Standards: SANS 1520-2	
CONSTRUCTION	
Conductors	Flexible class 5 comply to SANS 1411-1 from tinned annealed copper wires, left hand with semi-conducting rubber screen
Insulation	Ethylene propylene thermosetting compound type RD 3 comply to SANS 1411-3 and a strippable semi-conducting core screen (triple extruded)
Insulation screen	The braid of tinned copper wires
Cable assembly	Three tinned copper/nylon braid screened power cores and three unscreened pilot cores one in each interstice laid up in the right hand lay around semi-conductive filler centre. Alternatively, one pilot can be replaced with a tinned ECC conductor semi-conductive rubber covered)
Internal sheath	Poly-chloroprene thermosetting compound type RS 6 comply to SANS 1411-3
Reinforcing braid	An open nylon braid. Minimum 16 of nylon strings
Outer sheath	Poly-chloroprene thermosetting compound type RS 6 comply to SANS 1411-3. Inner and outer sheath are bonded to provide proper torsional protection, black
Physical properties	As per Table 1
Electrical properties	As per Table 2
Standard marking	TF KABLE 3 Type 66 ECC (Size) (Year). Legible and indelible embossing as per order
CHARACTERISTICS	
Excellent flexibility	
Abrasion, tear resistant and flame retardant	
Temperature range: minimum ambient temperature is -25°C. Maximum conductor temperature is +90°C	
UV, sunlight, ozone and oil resistant	
Application	Electrically driven machines, movable electric apparatus in hazardous areas, portable electric apparatus Section feeders. Open cast mining, medium sized draglines, shovels and drills. Suitable for reeling purposes Other industrial applications
Standard length cable packing	500 m on drums. Other forms of packing and delivery are available on request

Table 1

Physical properties									
Power cores									
Conductor sizes (mm ²)	25	35	50	70	95	120	150	185	240
Maximum wire diameter (mm)	0.41	0.41	0.41	0.51	0.51	0.51	0.51	0.51	0.51
Approximate conductor diameter (mm)	6.8	8.5	10.3	11.9	13.5	15.5	17.3	20.2	22.9
Maximum screen wire diameter (mm)	0.31	0.31	0.31	0.31	0.31	0.31	0.31	0.31	0.31
Braided screen filling factor (%)	60	60	60	60	60	60	60	60	60
Approximate summarized screen cross-section for power cores - weighing method (mm ²)	28	29	32	35	39	41	44	47	50
Pilot cores									
Conductor sizes (mm ²)	10	10	10	16	16	16	25	25	25
Maximum wire diameter (mm)	0.41	0.41	0.41	0.41	0.41	0.41	0.41	0.41	0.41
Approximate conductor diameter (mm)	4.2	4.2	4.2	5.3	5.3	5.3	6.8	6.8	6.8
ECC size (if applicable) (mm ²)	16	25	25	35	50	70	95	95	120
ECC maximum wire diameter (if applicable) (mm)	0.41	0.41	0.41	0.41	0.41	0.51	0.51	0.51	0.51
Lay ratio (maximum) (x PCD)	20	20	20	20	20	20	20	20	20
Approximate cable diameter * (mm)	50.1	51.7	55.3	59.8	64.6	68.8	73.1	77.8	83.1
Cable mass (approximate)									
Type 66 (kg/m)	3.8	4.2	5.1	6.2	7.4	8.7	10.2	11.7	14.1
Type 66 ECC (kg/m)	3.9	4.4	5.5	6.4	7.6	8.9	10.5	11.9	14.5
Minimum bending radius (mm)	430	450	480	520	550	590	650	670	740
Maximum recommended tension (kN)	1.1	1.6	2.3	3.2	4.3	5.4	6.8	8.3	10.8
* Tolerance - +/- 5% of approximate value									

Table 2

Electrical properties									
Power cores									
Maximum cond. DC resistance at 20°C (Ω/km)	0.795	0.565	0.393	0.277	0.210	0.164	0.132	0.108	0.0817
Maximum cond. DC resistance at 90°C (Ω/km)	1.05	0.749	0.521	0.368	0.279	0.218	0.176	0.145	0.110
Reactance (Ω/km)	0.124	0.116	0.109	0.105	0.101	0.096	0.092	0.091	0.087
Impedance (Z) at 90°C (Ω/km)	1.06	0.758	0.532	0.383	0.297	0.238	0.199	0.171	0.140
Minimum combined screen resistance at 23°C (Ω/km)	1.6	1.2	0.8	0.7	0.6	0.6	0.6	0.6	0.6
Minimum combined screen & ECC resistance (Ω/km)	0.7	0.5	0.5	0.4	0.3	0.23	0.18	0.18	0.15
Sustained current rating at 30°C ambient									
Laid out straight (A)	105	130	160	195	230	260	300	340	400
Short circuit rating									
Symmetrical fault current (kA for 1 sec)	3.1	4.3	6.1	8.5	11.6	14.6	18.3	23	29
Earth fault current - screens (kA for 1 sec)	1.6	2.1	3.1	3.5	4.1	4.1	4.1	4.1	4.1
Earth fault current - ECC + screens (kA for 1 sec)	3.6	5.0	5.0	7.5	9.0	11.5	14.0	14.0	17.0

TYPE 611, 611 ECC 6.35/11 kV

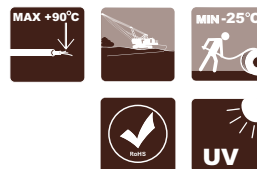

Flexible copper screened mining cables	
Standards: SANS 1520-2	
CONSTRUCTION	
Conductors	Flexible class 5 comply to SANS 1411-1 from tinned annealed copper wires, left hand with semi-conducting rubber screen
Insulation	Ethylene propylene thermosetting compound type RD 3 comply to SANS 1411-3 and a strippable semi-conducting core screen (triple extruded)
Insulation screen	The braid of tinned copper wires
Cable assembly	Three tinned copper/nylon braid screened power cores and three unscreened pilot cores one in each interstice laid up in the right hand lay around semi-conductive filler centre. (Alternatively, one pilot can be replaced with a tinned ECC).
Internal sheath	Poly-chloroprene thermosetting compound type RS 6 comply to SANS 1411-3
Reinforcing braid	An open nylon braid. Minimum 16 of nylon strings
Outer sheath	Poly-chloroprene thermosetting compound type RS 6 comply to SANS 1411-3. Inner and outer sheath are bonded to provide proper torsional protection, black
Physical properties	As per Table 1
Electrical properties	As per Table 2
Standard marking	TF KABLE 3 Type 611 (Size) (Year). Legible and indelible embossing as per order
CHARACTERISTICS	
Excellent flexibility	
Abrasion, tear resistant and flame retardant	
Temperature range: minimum ambient temperature is -25°C. Maximum conductor temperature is +90°C	
UV, sunlight, ozone and oil resistant	
Application	Electrically driven machines, movable electric apparatus in hazardous areas, portable electric apparatus. Section feeders. Open cast mining, medium sized draglines, shovels and drills. Suitable for reeling purposes Other industrial applications
Standard length cable packing	500 m on drums. Other forms of packing and delivery are available on request

Table 1

Physical properties									
Power cores									
Conductor sizes (mm ²)	25	35	50	70	95	120	150	185	240
Maximum wire diameter (mm)	0.41	0.41	0.41	0.51	0.51	0.51	0.51	0.51	0.51
Approximate conductor diameter (mm)	6.8	8.5	10.3	11.9	13.5	15.5	17.3	20.2	22.9
Maximum screen wire diameter (mm)	0.31	0.31	0.31	0.31	0.31	0.31	0.31	0.31	0.31
Braided screen filling factor (%)	60	60	60	60	60	60	60	60	60
Approximate summarized screen cross-section for power cores - weighing method (mm ²)	29	31	34	37	41	43	46	49	52
Pilot cores									
Conductor sizes (mm ²)	10	10	10	16	16	16	25	25	25
Maximum wire diameter (mm)	0.41	0.41	0.41	0.41	0.41	0.41	0.41	0.41	0.41
Approximate conductor diameter (mm)	4.2	4.2	4.2	5.3	5.3	5.3	6.8	6.8	6.8
ECC size - if applicable (mm ²)	16	25	25	35	50	70	95	95	120
ECC maximum wire diameter - if applicable (mm)	0.41	0.41	0.41	0.41	0.41	0.51	0.51	0.51	0.51
Lay ratio (maximum) (x PCD)	20	20	20	20	20	20	20	20	20
Approximate cable diameter * (mm)	50.7	52.2	59.4	60.4	65.2	71.3	75.0	85.1	85.6
Cable mass									
Type 611 (kg/km)	4.1	4.5	5.3	6.5	8.0	9.8	10.7	13.4	14.7
Type 611 ECC (kg/km)	4.2	4.6	5.4	6.7	8.2	10.2	10.9	13.9	15.0
Minimum bending radius (mm)	470	500	530	570	600	640	700	730	780
Maximum recommended tension (kN)	1.1	1.6	2.3	3.2	4.3	5.4	6.8	8.3	10.8
*Tolerance +/- 5% or approximate value									

Table 2

Electrical properties									
Power cores									
Maximum cond. DC resistance at 20°C (Ω/km)	0.795	0.565	0.393	0.277	0.210	0.164	0.132	0.108	0.0817
Maximum cond. DC resistance at 90°C (Ω/km)	1.05	0.749	0.521	0.368	0.279	0.218	0.176	0.145	0.110
Reactance (Ω/km)	0.134	0.124	0.117	0.113	0.108	0.103	0.098	0.096	0.092
Impedance (Z) at 90°C (Ω/km)	1.06	0.759	0.534	0.385	0.299	0.241	0.201	0.174	0.143
Minimum combined screen resistance at 23°C (Ω/km)	1.6	1.2	0.8	0.7	0.6	0.6	0.6	0.6	0.6
Minimum combined screen & ECC resistance (Ω/km)	0.7	0.5	0.5	0.4	0.3	0.23	0.18	0.18	0.15
Sustained current rating at 30°C ambient									
Laid out straight (A)	105	130	160	195	230	260	300	340	400
Short circuit rating									
Symmetrical fault current (kA for 1 sec)	3.1	4.3	6.1	8.5	11.6	14.6	18.3	22.57	29.30
Earth fault current - screens (kA for 1 sec)	1.6	2.1	3.1	3.5	4.1	4.1	4.1	4.1	4.1
Earth fault current ECC + screens (kA for 1 sec)	3.6	5.0	5.0	7.5	9.0	11.5	14.0	14.0	17.0

TYPE 622, 622ECC 12.7/22 kV



Flexible copper screened mining cables	
Standards: in line with SANS 1520-2	
CONSTRUCTION	
Conductors	Flexible class 5 comply to SANS 1411-1 from tinned annealed copper wires, left hand with semi-conducting rubber screen
Insulation	Ethylene propylene thermosetting compound type RD 3 comply to SANS 1411-3 and a strippable semi-conducting core screen (triple extruded)
Insulation screen	The braid of tinned copper wires
Cable assembly	Three tinned copper/nylon braid screened power cores and three unshielded pilot cores one in each interstice laid up in the right hand lay around semi-conductive filler centre. (Alternatively, one pilot can be replaced with a tinned ECC).
Internal sheath	Poly-chloroprene thermosetting compound type RS 6 comply to SANS 1411-3
Reinforcing braid	An open nylon braid. Minimum 16 of nylon strings
Outer sheath	Poly-chloroprene thermosetting compound type RS 6 comply to SANS 1411-3. Inner and outer sheath are bonded to provide proper torsional protection, black
Physical properties	As per Table 1
Electrical properties	As per Table 2
Standard marking	TF KABLE 3 Type 611 (Size) (Year). Legible and indelible embossing as per order
CHARACTERISTICS	
Excellent flexibility	
Abrasion, tear resistant and flame retardant	
Temperature range: minimum ambient temperature is -25°C. Maximum conductor temperature is +90°C	
UV, sunlight, ozone and oil resistant	
Application	Electrically driven machines, movable electric apparatus in hazardous areas, portable electric apparatus. Section feeders. Open cast mining, medium sized draglines, shovels and drills. Suitable for reeling purposes Other industrial applications
Standard length cable packing	500 m on drums. Other forms of packing and delivery are available on request

Table 1

Physical properties							
Power cores							
Conductor sizes (mm ²)	25	35	50	70	95	120	150
Maximum wire diameter (mm)	0.41	0.41	0.41	0.51	0.51	0.51	0.51
Approximate conductor diameter (mm)	6.8	8.5	10.3	11.9	13.5	15.5	17.3
Maximum screen wire diameter (mm)	0.31	0.31	0.31	0.31	0.31	0.31	0.31
Braided screen filling factor (%)	60	60	60	60	60	60	60
Pilot cores							
Conductor sizes (mm ²)	10	10	10	16	16	16	25
Maximum wire diameter (mm)	0.41	0.41	0.41	0.41	0.41	0.41	0.41
Approximate conductor diameter (mm)	4.2	4.2	4.2	4.2	4.2	4.2	6.8
ECC size - if applicable (mm ²)	16	25	25	35	50	70	95
ECC maximum wire diameter - if applicable (mm)	0.41	0.41	0.41	0.41	0.41	0.51	0.51
Lay ratio (maximum) (x PCD)	20	20	20	20	20	20	20
Approximate cable diameter* (mm)	60.6	64.9	68.5	72.4	77.1	81.4	85.6
Cable mass							
Type 622 (kg/km)	5.5	6.4	7.2	8.3	9.6	11.0	12.6
Type 622 ECC (kg/km)	5.5	6.4	7.3	8.4	9.8	11.3	13.0
Minimum bending radius (mm)	640	580	610	640	670	710	780
Maximum recommended tension (kN)	1.1	1.6	2.3	3.2	4.3	5.4	6.8
* Tolerance +/- 5% or approximate value							

Table 2

Electrical properties							
Power cores							
Maximum cond. DC resistance at 20°C (Ω/km)	0.795	0.565	0.393	0.277	0.210	0.164	0.132
Maximum cond. DC resistance at 90°C (Ω/km)	1.05	0.749	0.521	0.368	0.279	0.218	0.176
Reactance (Ω/km)	0.145	0.135	0.127	0.122	0.117	0.111	0.106
Minimum combined screen resistance at 23°C (Ω/km)	1.6	1.2	0.8	0.7	0.6	0.6	0.6
Minimum combined screen & ECC resistance (Ω/km)	0.7	0.5	0.5	0.4	0.3	0.23	0.18
Sustained current rating at 30°C ambient							
Laid out straight (A)	105	130	160	195	230	260	300
Short circuit rating							
Symmetrical fault current (kA for 1 sec)	3.1	4.3	6.1	8.5	11.6	14.6	18.3
Earth fault current - screens (kA for 1 sec)	1.6	2.1	3.1	3.5	4.1	4.1	4.1
Earth fault current ECC + screens (kA for 1 sec)	3.6	5.0	5.0	7.5	9.0	11.5	14.0

TYPE 633, 633ECC 19/33 kV

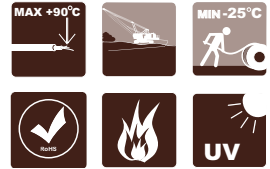

Flexible copper screened mining cables	
Standards: in line with SANS 1520-2	
CONSTRUCTION	
Conductors	Flexible class 5 comply to SANS 1411-1 from tinned annealed copper wires, left hand with semi-conducting rubber screen
Insulation	Ethylene propylene thermosetting compound type RD 3 comply to SANS 1411-3 and a strippable semi-conducting core screen (triple extruded)
Insulation screen	The braid of tinned copper wires
Cable assembly	Three tinned copper/nylon braid screened power cores and three unscreened pilot cores one in each interstice laid up in the right hand lay around semi-conductive filler centre. (Alternatively, one pilot can be replaced with a tinned ECC).
Internal sheath	Poly-chloroprene thermosetting compound type RS 6 comply to SANS 1411-3
Reinforcing braid	An open nylon braid. Minimum 16 of nylon strings
Outer sheath	Poly-chloroprene thermosetting compound type RS 6 comply to SANS 1411-3. Inner and outer sheath are bonded to provide proper torsional protection, black
Physical properties	As per Table 1
Electrical properties	As per Table 2
Standard marking	TF KABLE 3 Type 611 (Size) (Year). Legible and indelible embossing as per order
CHARACTERISTICS	
Excellent flexibility	
Abrasion, tear resistant and flame retardant	
Temperature range: minimum ambient temperature is -25°C. Maximum conductor temperature is +90°C	
UV, sunlight, ozone and oil resistant	
Application	Electrically driven machines, movable electric apparatus in hazardous areas, portable electric apparatus. Section feeders. Open cast mining, medium sized draglines, shovels and drills. Suitable for reeling purposes Other industrial applications
Standard length cable packing	500 m on drums. Other forms of packing and delivery are available on request

Table 1

Physical properties						
Power cores						
Conductor sizes (mm ²)	25	35	50	70	95	120
Maximum wire diameter (mm)	0.41	0.41	0.41	0.51	0.51	0.51
Approximate conductor diameter (mm)	6.8	8.5	10.3	11.9	13.5	15.5
Maximum screen wire diameter (mm)	0.31	0.31	0.31	0.31	0.31	0.31
Braided screen filling factor (%)	60	60	60	60	60	60
Pilot cores						
Conductor sizes (mm ²)	16	16	16	16	16	16
Maximum wire diameter (mm)	0.41	0.41	0.41	0.41	0.41	0.41
Approximate conductor diameter (mm)	4.2	4.2	4.2	4.2	4.2	4.2
ECC size - if applicable (mm ²)	16	25	25	35	50	70
ECC maximum wire diameter - if applicable (mm)	0.41	0.41	0.41	0.41	0.41	0.51
Lay ratio (maximum) (x PCD)	20	20	20	20	20	20
Approximate cable diameter* (mm)	71.3	73.5	77.8	83.0	87.8	90.0
Cable mass						
Type 622 (kg/km)	7.2	7.8	8.9	10.3	11.7	12.7
Type 622 ECC (kg/km)	7.2	7.8	8.8	10.4	11.9	13.1
Minimum bending radius (mm)	620	650	680	710	740	780
Maximum recommended tension (kN)	1.1	1.6	2.3	3.2	4.3	5.4
*Tolerance +/- 5% or approximate value						

Table 2

Electrical properties						
Power cores						
Maximum cond. DC resistance at 20°C (Ω/km)	0.795	0.565	0.393	0.277	0.210	0.164
Maximum cond. DC resistance at 90°C (Ω/km)	1.05	0.749	0.521	0.368	0.279	0.218
Reactance (Ω/km)	0.155	0.144	0.136	0.131	0.125	0.119
Minimum combined screen resistance at 23°C (Ω/km)	1.6	1.2	0.8	0.7	0.6	0.6
Minimum combined screen & ECC resistance (Ω/km)	0.7	0.5	0.5	0.4	0.3	0.23
Sustained current rating at 30°C ambient						
Laid out straight (A)	105	130	160	195	230	260
Short circuit rating						
Symmetrical fault current (kA for 1 sec)	3.1	4.3	6.1	8.5	11.6	14.6
Earth fault current - screens (kA for 1 sec)	1.6	2.1	3.1	3.5	4.1	4.1
Earth fault current ECC + screens (kA for 1 sec)	3.6	5.0	5.0	7.5	9.0	11.5

MINING FLEXIBLE CABLE 640/1100 V

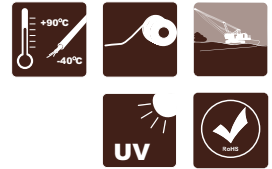

Flexible, copper screened rubber insulated and sheathed cables	
Standards: In line with SANS 1520-1	
CONSTRUCTION	
Conductors	Flexible class 5 comply to SANS 1411-1 from tinned annealed copper wires
Separator	A suitable tape separator between the conductor and insulation
Insulation	Ethylene propylene thermosetting compound type RD 6 comply to SANS 1411-3
Core of cable	Three tinned copper/nylon braid screened power cores and two unscreened pilot core and one tinned earth conductor laid up in the right hand lay around rubber type RD1 dummy centre
Outer sheath	Extra heavy duty yellow CM sheath type RS 6 comply to SANS 1411
Physical properties	As per table 1
Electrical properties	As per table 2
Flame propagation	IEC 60332-1-2:2004, EN 60332-1-2:2004
Standard marking	TF KABLE 3 MINING FLEXIBLE (Size) (Voltage) (Year)
CHARACTERISTICS	
Excellent flexibility	
Water resistant and flame retardant	
Temperature range -25°C to +90°C. For fixed installation lowest temperature is -40°C	
UV, sunlight, ozone and oil resistant	
Legible and indelible ink jet or embossing (for 25 mm² and larger) marking as per order	
Application	Submersible pumps, on board wiring for machines Single, double, triple drilling rigs, loaders, low haulage dumpers, loaders, large drilling rigs Other industrial applications
Standard length cable packing	1000 m on drums. Other forms of packing and delivery are available on request

Table 1

Physical properties							
Power cores							
Conductor sizes (mm ²)	2.5	10	16	25	35	50	70
Maximum wire diameter (mm)	0.26	0.41	0.41	0.41	0.41	0.41	0.51
Approximate conductor diameter (mm)	2.1	4.2	5.3	6.8	8.5	10.3	11.9
Maximum screen wire diameter (mm)	0.21	0.31	0.31	0.31	0.31	0.31	0.31
Braided screen filling factor (%)	80	80	80	80	80	80	80
Approximate summarized screen cross-section for power cores - weighting method (mm ²)	8	19	22	25	27	32	37
Pilot cores							
Number of pilot cores	-	2	2	2	2	2	2
Conductor sizes (mm ²)	-	4	4	6	6	10	10
Maximum wire diameter (mm)	-	0.31	0.31	0.31	0.31	0.41	0.41
Approximate conductor diameter (mm)	-	2.7	2.7	4.2	4.2	5.3	5.3
Earth cores							
Number of earth cores	1	1	1	1	1	1	1
Conductor sizes (mm ²)	1.5	6	10	16	16	25	35
Maximum wire diameter (mm)	0.26	0.41	0.41	0.41	0.41	0.41	0.41
Approximate conductor diameter (mm)	1.7	3.3	4.2	5.3	5.3	6.8	8.5
Lay Ratio (maximum) (x PCD)	12	8	8	8	8	8	8
Cable diameter							
Minimum (mm)	16.5	-	34.5	36.4	37.0	43.6	50.1
Maximum (mm)	18.3	-	37.5	37.7	40.0	46.9	54.0
Cable mass (approx.) (kg/m)	0.52	1.50	2.20	2.74	3.10	4.01	5.41
Minimum bending radius (mm)	100	-	210	310	320	370	430
Maximum recommended tension (kN)	0.12	0.50	0.79	1.24	1.73	2.48	3.47

Table 2

Electrical properties							
Power cores							
Maximum cond. DC resistance at 20°C (Ω/km)	8.54	2.11	1.34	0.859	0.610	0.424	0.299
Maximum cond. DC resistance at 90°C (Ω/km)	11.39	2.69	1.79	1.15	0.814	0.566	0.399
Reactance (Ω/km)	0.121	0.108	0.103	0.100	0.090	0.090	0.088
Impedance (Z) at 90°C (Ω/km)	11.39	2.69	1.79	1.15	0.819	0.573	0.409
Sustained current rating at 30°C ambient							
Laid out straight (A)	35	100	111	141	181	221	270
1 layer on drum (A)	29	81	91	120	151	180	231
2 layer on drum (A)	23	61	71	91	121	141	181
3 layer on drum (A)	16	41	51	61	81	101	121
Short circuit rating							
Symmetrical fault current (kA for 1 sec)	0.3	1.1	1.8	2.8	4.0	5.7	7.9
Earth fault current - screens (kA for 1 sec)	0.3	0.6	1.0	1.6	2.1	3.1	3.5

We look into
the future



AUSTRALIAN/NEW ZEALAND STANDARDS AS/NZ

TYPE 209 1.1 to 11 kV	126
TYPE 240 1.1 to 11 kV	129
TYPE 241 1.1 to 11 kV	132
TYPE 275 1.1/1.1 kV	135
TYPE 409 1.1 to 22 kV	136
TYPE 440 1.1 to 22 kV	139
TYPE 441 1.1 to 22 kV	142
TYPE 450 3.3 to 33 kV	146
TYPE 455 3.3 to 33 kV	149
TYPE 2S 0.6/1 kV	152

TYPE 209 1.1 to 11 kV

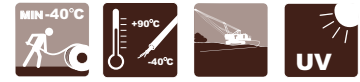

Flexible copper screened mining cable	
Standards: AS/NZS 1802: 2003	
CONSTRUCTION	
Conductors	Tinned annealed copper wires comply with AS/NZS 1125:2001 and tab 3 AS/NZS 1802:2003
Separator/screen	For 1.1/1.1 kV paper separator. For other nominal voltages semi-conductive thermosetting compound over conductors
Insulation	Ethylene propylene rubber type R-EP-90
Insulation screen	Synthetic tape for voltage 1.1/1.1 kV or for voltage from 3.3/3.3 kV semi-conductive thermosetting compound+ tinned copper/polyamide braid to AS/NZS 1802:2003
Cable assembly	Three screened power laid up with right hand direction on cradle separator with central pilot core
Cradle separator	Semi-conductive thermosetting compound comply to AS/NZS 1802:2003
Sheath	Thermosetting compound HD-85-PCP - extra heavy duty, oil resistance and flame retardant
Standard marking	TF KABLE 3 R-EP- 90 HD-85-PCP TYPE 209.1 (Year) (Size of power)
CHARACTERISTICS	
Excellent flexibility	
Water resistant and flame retardant	
Temperature range: -25°C to +90°C	
UV, sunlight, ozone and oil resistant	
Embossing printed for easy identification	
Application	For use as flexible feeder cable to machinery More suitable as a trailing cable Smaller sizes used for drills, held hand tools and equipment Other industrial applications
Standard length cable packing	500 m on drums. Other forms of packing and delivery are available on request

Nominal conductor area	Thickness of insulation	Number and nominal diameter of wires	Nominal diameter over insulation	Core screen size	Area of screen	Nominal thickness of sheath	Nominal overall diameter	Approximate weight
mm ²	mm	n x mm	n x mm	mm	mm ²	mm	mm	kg/100m
Type 209.1								
6	1.5	84x0.3	6.5	7/0.25	7.2	3.8	30.0	129
10	1.5	77x0.4	7.7	7/0.25	8.6	3.8	32.6	157
16	1.6	126x0.4	9.0	7/0.25	9.6	4.0	35.8	157
25	1.6	209x0.4	10.5	7/0.25	11.3	4.3	39.7	255
35	1.6	285x0.4	12.1	7/0.25	12.4	4.6	43.1	312
50	1.7	380x0.4	13.8	7/0.25	14.1	5.0	48.4	386
70	1.8	361x0.5	16.1	7/0.25	16.5	5.4	54.0	503
95	2.0	475x0.5	17.7	7/0.25	18.2	6.0	58.8	605
120	2.1	608x0.5	20.0	7/0.25	20.3	6.4	64.6	741
150	2.3	740x0.5	22.2	7/0.25	22.3	6.9	70.3	896
185	2.5	925x0.5	24.7	7/0.30	30.2	7.4	74.8	1107
240	2.8	1221x0.5	27.9	7/0.30	33.6	8.2	86.1	1365
300	3.0	1525x0.5	31.0	7/0.40	50.1	8.8	95.2	1715
Type 209.3								
16	3.0	126x0.4	12.6	7/0.25	13.4	5.3	46.7	301
25	3.0	209x0.4	14.1	7/0.25	14.8	5.6	50.6	369
35	3.0	285x0.4	15.4	7/0.25	15.1	5.9	54.0	431
50	3.0	380x0.4	16.9	7/0.25	17.5	6.3	58.1	507
70	3.0	361x0.5	18.9	7/0.25	19.6	6.6	63.0	624
95	3.0	475x0.5	20.1	7/0.25	20.6	7.1	66.7	719
120	3.0	608x0.5	22.2	7/0.30	27.2	7.4	72.6	876
150	3.0	740x0.5	24.0	7/0.40	39.6	7.8	78.6	1072
185	3.0	925x0.5	26.1	7/0.40	43.1	8.2	83.8	1236
240	3.0	1221x0.5	28.1	7/0.40	46.6	8.8	90.8	1484
Type 209.6								
16	5.0	126x0.4	16.6	7/0.25	17.2	6.4	57.9	435
25	5.0	209x0.4	18.1	7/0.25	18.9	6.7	61.7	512
35	5.0	285x0.4	19.4	7/0.25	19.9	7.0	65.2	582
50	5.0	380x0.4	20.9	7/0.25	21.6	7.3	69.0	668
70	5.0	361x0.5	22.9	7/0.25	23.4	7.7	74.3	799
95	5.0	475x0.5	24.1	7/0.30	29.7	8.1	78.3	876
120	5.0	608x0.5	25.2	7/0.30	32.2	8.5	83.5	1072
150	5.0	740x0.5	28.0	7/0.40	45.7	8.9	89.5	1290
185	5.0	925x0.5	30.1	7/0.40	49.3	9.3	95.1	1466
240	5.0	1221x0.5	32.7	7/0.40	52.8	9.9	101.8	1733
Type 209.11								
25	7.6	209x0.4	23.5	7/0.25	24.1	8.1	76.0	742
35	7.6	285x0.4	24.8	7/0.30	30.2	8.4	80.1	847
50	7.6	380x0.4	26.2	7/0.30	32.2	8.7	84.0	943
70	7.6	361x0.5	28.2	7/0.30	34.6	9.1	89.1	1093

Nominal conductor area	Thickness of insulation	Number and nominal diameter of wires	Nominal diameter over insulation	Core screen size	Area of screen	Nominal thickness of sheath	Nominal overall diameter	Approximate weight
mm ²	mm	n x mm	n x mm	mm	mm ²	mm	mm	kg/100m
95	7.6	475x0.5	29.5	7/0.40	48.4	9.6	94.1	1267
120	7.6	608x0.5	31.5	7/0.40	51.0	9.9	99.9	1436
150	7.6	740x0.5	33.3	7/0.40	54.5	10.3	104.0	1614

TYPE 240 1.1 to 11 kV

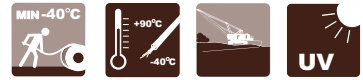

Flexible copper screened mining cable with three pilots	
Standards: AS/NZS 1802: 2003	
CONSTRUCTION	
Conductors	Tinned annealed copper wires comply with AS/NZS 1125: 2001 and tab 3 AS/NZS 1802: 2003
Separator/screen	For 1.1/1.1 kV paper separator. For other nominal voltages semi-conductive thermosetting compound over conductors
Insulation	Ethylene-propylene compound type R-EP-90
Insulation screen	Synthetic tape for voltage 1.1/1.1 kV or for voltage from 3.3/3.3 kV semi-conductive thermosetting compound+tinned copper/polyamide braid to AS/NZS 1802: 2003
Cable assembly	Three screened power laid up with right hand direction on cradle separator
Cradle separator	Semi-conductive thermosetting compound comply to AS/NZS 1802: 2003
Sheath	Thermosetting compound HD-85-PCP - extra heavy duty, oil resistance and flame retardant. Optional an open polyamide braid between layer of jacket
Standard marking	TF KABLE 3 R-EP-90/HD-85-PCP TYPE 240.1 (Year) (Size of power)
CHARACTERISTICS	
Excellent flexibility	
Water resistant and flame retardant	
Temperature range -25°C to +90°C	
UV, sunlight, ozone and oil resistant	
Embossing printed for easy identification	
Application	For use as flexible feeder cable to machinery or longwall supply Other industrial applications
Standard length cable packing	500 m on drums. Other forms of packing and delivery are available on request

Nominal conductor area	Thickness of insulation	Number and nominal diameter of wires	Nominal diameter over insulation	Core screen size	Area of screen	Nominal thickness of sheath	Nominal overall diameter	Approximate weight
mm ²	mm	n x mm	n x mm	mm	mm ²	mm	mm	kg/100m
Type 209.1								
6	1.5	84x0.3	6.5	7/0.25	7.2	3.8	30.0	131
10	1.5	77x0.4	7.7	7/0.25	8.6	3.8	32.6	159
16	1.6	126x0.4	9.0	7/0.25	9.6	4.0	35.8	202
25	1.6	209x0.4	10.5	7/0.25	11.3	4.3	39.7	265
35	1.6	285x0.4	12.1	7/0.25	12.4	4.6	53.6	326
50	1.7	380x0.4	13.8	7/0.25	14.1	5.0	48.4	404
70	1.8	361x0.5	16.1	7/0.25	16.5	5.4	54.0	533
95	2.0	475x0.5	17.7	7/0.25	18.2	6.0	58.8	635
120	2.1	608x0.5	20.0	7/0.25	20.3	6.4	64.6	775
150	2.3	740x0.5	22.2	7/0.25	22.3	6.9	70.3	940
185	2.5	925x0.5	24.7	7/0.30	30.2	7.4	77.5	1140
240	2.8	1221x0.5	27.9	7/0.30	33.6	8.2	86.1	1410
300	3.0	1525x0.5	31.0	7/0.40	50.1	8.8	95.2	1775
Type 209.3								
16	3.0	126x0.4	12.6	7/0.25	13.4	5.3	46.7	306
25	3.0	209x0.4	14.1	7/0.25	14.8	5.6	50.6	379
35	3.0	285x0.4	15.4	7/0.25	15.1	5.9	54.0	444
50	3.0	380x0.4	16.9	7/0.25	17.5	6.3	58.1	525
70	3.0	361x0.5	18.9	7/0.25	19.6	6.6	63.0	656
95	3.0	475x0.5	20.1	7/0.25	20.6	7.1	66.7	750
120	3.0	608x0.5	22.2	7/0.30	27.2	7.4	72.6	910
150	3.0	740x0.5	24.0	7/0.40	39.6	7.8	78.6	1115
185	3.0	925x0.5	26.1	7/0.40	43.1	8.2	83.8	1280
240	3.0	1221x0.5	28.1	7/0.40	46.6	8.8	90.8	1540
Type 209.6								
16	5.0	126x0.4	16.6	7/0.25	17.2	6.4	57.9	440
25	5.0	209x0.4	18.1	7/0.25	18.9	6.7	61.7	521
35	5.0	285x0.4	19.4	7/0.25	19.9	7.0	65.2	593
50	5.0	380x0.4	20.9	7/0.25	21.6	7.3	69.0	685
70	5.0	361x0.5	22.9	7/0.25	23.4	7.7	74.3	830
95	5.0	475x0.5	24.1	7/0.30	29.7	8.1	78.3	954
120	5.0	608x0.5	25.2	7/0.30	32.2	8.5	83.5	1111
150	5.0	740x0.5	28.0	7/0.40	45.7	8.9	89.5	1335
185	5.0	925x0.5	30.1	7/0.40	49.3	9.3	95.1	1515
240	5.0	1221x0.5	32.7	7/0.40	52.8	9.9	101.8	1788
Type 209.11								
25	7.6	209x0.4	23.5	7/0.25	24.1	8.1	76.0	752
35	7.6	285x0.4	24.8	7/0.30	30.2	8.4	80.1	860
50	7.6	380x0.4	26.2	7/0.30	32.2	8.7	84.0	961
70	7.6	361x0.5	28.2	7/0.30	34.6	9.1	89.1	1125

Nominal conductor area	Thickness of insulation	Number and nominal diameter of wires	Nominal diameter over insulation	Core screen size	Area of screen	Nominal thickness of sheath	Nominal overall diameter	Approximate weight
mm ²	mm	n x mm	n x mm	mm	mm ²	mm	mm	kg/100m
95	7.6	475x0.5	29.5	7/0.40	48.4	9.6	94.1	1300
120	7.6	608x0.5	31.5	7/0.40	51.0	9.9	99.9	1470
150	7.6	740x0.5	33.3	7/0.40	54.5	10.3	104.0	1659

TYPE 241 1.1 to 11 kV

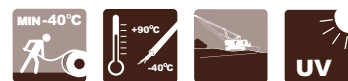

Flexible rubber screened mining cables	
Standards: AS/NZS 1802: 2003	
CONSTRUCTION	
Conductors	Tinned annealed copper wires comply with AS/NZS 1125: 2001 and tab 3 AS/NZS 1802: 2003
Separator/screen	For 1.1/1.1 kV paper separator. For other nominal voltages semi-conductive thermosetting compound over conductors
Insulation	Ethylene-propylene compound type R-EP-90
Insulation screen	Semi-conductive thermosetting compound to Table 7 of AS/NZS 1802: 2003
Cable assembly	Three screened power and three earth cores laid up with right hand direction on cradle separator with central pilot core
Internal sheath, earth covering, cradle separator	Semi-conductive thermosetting compound comply to Table 6 and 7 of AS/NZS 1802: 2003
Reinforcing braid	Polyamide yarns
Sheath	Thermosetting compound HD-90-CSP - extra heavy duty, oil resistance and flame retardant
Standard marking	TF KABLE 3 R-EP- 90/HD-90-CSP TYPE 241.1 (Year) (Size of power)
CHARACTERISTICS	
Excellent flexibility	
Water resistant and flame retardant	
Temperature range -25°C to +90°C	
UV, sunlight, ozone and oil resistant	
Embossing printed for easy identification	
Application	For general and underground coal mining purposes For various uses including mine power feeder cable for continuous miners, pump cable and power supply cable Other industrial applications
Standard length cable packing	500 m on drums. Other forms of packing and delivery are available on request

Power conductor			Earth conductor		Thickness of sheath including semi-conducting layer	Nominal overall diameter	Approximate weight
Nominal area	Thickness of insulation	Number and nominal diameter of wires	Number and nominal diameter of wires	Thickness of semi-conducting covering			
mm ²	mm	n x mm	n x mm	mm	mm	mm	kg/100 m
Type 241.1							
6	1.5	84x0.3	18x0.3	1.0	3.8	29.7	106
10	1.5	77x0.4	27x0.3	1.0	3.8	31.6	127
16	1.6	126x0.4	42x0.3	1.0	3.9	35.0	164
25	1.6	209x0.4	66x0.3	1.0	4.2	37.9	208
35	1.6	285x0.4	90x0.3	1.0	4.4	39.8	254
50	1.7	380x0.4	120x0.3	1.0	4.9	45.2	328
70	1.8	361x0.5	110x0.4	1.0	5.3	50.0	425
95	2.0	475x0.5	110x0.4	1.0	5.8	56.0	532
120	2.1	608x0.5	110x0.4	1.2	6.3	59.5	633
150	2.3	740x0.5	135x0.4	1.2	6.7	64.9	766
185	2.5	925x0.5	165x0.4	1.4	7.3	71.3	924
240	2.8	1221x0.5	216x0.4	1.4	8.0	76.9	1147
300	3.0	1525x0.5	275x0.4	1.4	8.7	86.4	1426
Type 241.3							
16	3.0	126x0.4	42x0.3	1.0	5.0	44.0	249
25	3.0	209x0.4	66x0.3	1.0	5.3	47.9	315
35	3.0	285x0.4	90x0.3	1.0	5.6	51.3	376
50	3.0	380x0.4	120x0.3	1.0	6.0	55.4	450
70	3.0	361x0.5	110x0.4	1.0	6.4	60.7	576
95	3.0	475x0.5	135x0.5	1.0	6.8	64.1	675
120	3.0	608x0.5	165x0.4	1.2	7.2	69.2	810
150	3.0	740x0.5	216x0.4	1.2	7.6	74.0	952
185	3.0	925x0.5	252x0.4	1.4	8.0	79.3	1112
240	3.0	1221x0.5	324x0.4	1.4	8.6	86.1	1360
300	3.0	1525x0.5	259x0.5	1.4	9.1	92.7	1640
Type 241.6							
16	5.0	126x0.4	42x0.3	1.4	6.1	55.2	365
25	5.0	209x0.4	66x0.3	1.4	6.4	59.1	440
35	5.0	285x0.4	90x0.3	1.4	6.7	62.6	509
50	5.0	380x0.4	120x0.3	1.4	7.1	66.4	592
70	5.0	361x0.5	110x0.4	1.4	7.4	71.3	727
95	5.0	475x0.5	135x0.4	1.4	7.9	75.0	835
120	5.0	608x0.5	165x0.4	1.4	8.3	80.3	990
150	5.0	740x0.5	216x0.4	1.4	8.6	84.8	1140
185	5.0	925x0.5	252x0.4	1.4	9.0	90.1	1311
240	5.0	1221x0.5	324x0.4	1.4	9.6	96.9	1576
Type 241.11							
25	7.6	209x0.4	66x0.3	1.8	7.8	73.4	645
35	7.6	285x0.4	90x0.3	1.8	8.1	76.7	724

Power conductor			Earth conductor		Thickness of sheath including semi-conducting layer	Nominal overall diameter	Approximate weight
Nominal area	Thickness of insulation	Number and nominal diameter of wires	Number and nominal diameter of wires	Thickness of semi-conducting covering			
mm ²	mm	n x mm	n x mm	mm	mm	mm	kg/100 m
50	7.6	380x0.4	120x0.3	1.8	8.5	80.7	825
70	7.6	361x0.5	110x0.4	1.8	8.9	85.9	975
95	7.6	475x0.5	135x0.4	1.8	9.3	89.2	1088
120	7.6	608x0.5	165x0.4	1.8	9.7	94.5	1258
150	7.6	740x0.5	216x0.4	1.8	10.0	99.0	1423
185	7.6	925x0.5	252x0.4	1.8	10.4	104.3	1610

TYPE 275 1.1/1.1 kV

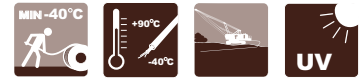
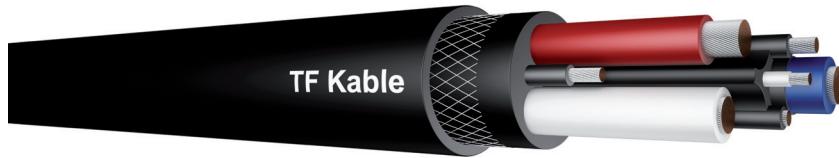

Flexible overall semi-conductive rubber screened mining cables	
Standards: AS/NZS 1802: 2003	
CONSTRUCTION	
Conductors	Tinned annealed copper wires comply with AS/NZS 1125: 2001 and tab 3 AS/NZS 1802: 2003
Separator	Synthetic tape under insulation
Insulation	Ethylene-propylene compound type R-EP-90
Cable assembly	Three insulated power and three earth cores laid up with right hand direction on cradle separator with central pilot core
Internal sheath, earth covering, cradle separator	Semi-conductive thermosetting compound comply to Table 6 and 7 of AS/NZS 1802: 2003
Reinforcing braid	Polyamide yarns
Sheath	Thermosetting compound HD-90-CSP - extra heavy duty, oil resistance and flame retardant
Standard marking	TF KABLE 3 R-EP- 90/HD-90-CSP TYPE 275.1 (Year) (Size of power)
CHARACTERISTICS	
Excellent flexibility	
Water resistant and flame retardant	
Temperature range -25°C to +90°C	
UV, sunlight, ozone and oil resistant	
Embossing printed for easy identification	
Application	For general and underground coal mining purposes For shuttle cars and pump cable Other industrial applications
Standard length cable packing	500 m on drums. Other forms of packing and delivery are available on request

Power conductor			Earth conductor		Thickness of sheath including semi-conducting layer	Nominal overall diameter	Approximate weight
Nominal area	Thickness of insulation	Number and nominal diameter of wires	Number and nominal diameter of wires	Thickness of semi-conducting covering			
mm ²	mm	n x mm	n x mm	mm	mm	mm	kg/100 m
16	1.6	126x0.4	60x0.3	1.0	3.8	30.2	1450
25	1.6	209x0.4	100x0.3	1.0	4.0	33.9	2040
35	1.6	285x0.4	140x0.3	1.0	4.3	38.5	2701
50	1.7	380x0.4	99x0.4	1.0	4.7	43.1	3334

TYPE 409 1.1 to 22 kV

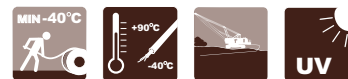

Flexible copper screened mining cable with central pilot	
Standards: AS/NZS 2802: 2000	
CONSTRUCTION	
Conductors	Tinned annealed copper wires comply with AS/NZS 1125:2001 and AS/NZS 2802:2000
Separator/screen	For 1.1/1.1 kV paper separator. For other nominal voltages semi-conductive tape+ thermosetting compound over conductors
Insulation	Ethylene propylene rubber type R-EP-90
Insulation screen	Synthetic tape for voltage 1.1/1.1 kV or for voltage from 3.3/3.3 kV semi-conductive thermosetting compound+ tinned copper/polyamide braid comply to 12.4.1 AS/NZS 2802
Cable assembly	Three screened power laid up with right hand direction on cradle separator with central pilot core
Sheath	Thermosetting compound HD-85-PCP - extra heavy duty, oil resistance and flame retardant
Standard marking	TF KABLE 3 R-EP- 90 HD-85-PCP TYPE 409.1 (Year) (Size of power)
CHARACTERISTICS	
Excellent flexibility	
Water resistant and flame retardant	
Temperature range: -25°C to +90°C	
UV, sunlight, ozone and oil resistant	
Embossing printed for easy identification	
Application	For use as flexible feeder cable to machinery More suitable as a trailing cable Larger cables for power supply to draglines, shovels and drills Smaller sizes used for drills, held hand tools and equipment Other industrial applications
Standard length cable packing	500 m on drums. Other forms of packing and delivery are available on request

Nominal conductor area	Thickness of insulation	Number and nominal diameter of wires	Nominal diameter over insulation	Core screen size	Area of screen	Pilot cond. Strand/size	Thickness EPR covering	Nominal thickness of sheath	Nominal overall diameter	Approximate weight
mm ²	mm	n x mm	mm	mm	mm ²	No/mm	mm	mm	mm	kg/100 m
Type 409.1										
6	1.5	84x0.3	6.5	7/0.25	7.2	24/0.2	0.8	3.8	30.0	129
10	1.5	77x0.4	7.7	7/0.25	8.6	24/0.2	0.8	3.8	32.6	157
16	1.6	126x0.4	9.0	7/0.25	9.6	24/0.2	0.8	4.0	35.8	157
25	1.6	209x0.4	10.5	7/0.25	11.3	24/0.2	0.8	4.3	39.7	255
35	1.6	285x0.4	12.1	7/0.25	12.4	24/0.2	0.8	4.6	43.8	312
50	1.7	380x0.4	13.8	7/0.25	14.4	40/0.2	0.8	5.0	48.4	386
70	1.8	361x0.5	16.1	7/0.25	16.5	40/0.2	0.8	5.4	54.0	503
95	2.0	475x0.5	17.7	7/0.30	21.8	40/0.2	0.8	6.0	59.4	622
120	2.1	608/0.5	20.0	7/0.30	24.7	40/0.2	0.8	6.4	65.2	760
150	2.3	740/0.5	22.2	7/0.40	36.9	40/0.2	0.8	6.9	72.2	960
185	2.5	925x0.5	24.7	7/0.40	40.5	40/0.2	0.8	7.4	78.8	1139
240	2.8	1221x0.5	27.9	7/0.50	57.7	40/0.2	0.8	8.2	88.7	1465
300	3.0	1525x0.5	31.0	7/0.50	63.2	40/0.2	0.8	8.8	96.5	1790
Type 409.3										
16	3.0	126x0.4	12.5	7/0.25	13.1	24/0.2	0.8	5.3	46.3	301
25	3.0	209x0.4	14.0	7/0.25	14.8	24/0.2	0.8	5.6	50.0	371
35	3.0	285x0.4	15.3	7/0.25	15.8	24/0.2	0.8	5.9	53.5	430
50	3.0	380x0.4	16.8	7/0.25	17.2	40/0.2	0.8	6.3	57.5	511
70	3.0	361x0.5	18.8	7/0.25	18.6	40/0.2	0.8	6.6	62.4	624
95	3.0	475x0.5	20.0	7/0.30	20.3	40/0.2	0.8	7.1	66.1	724
120	3.0	608x0.5	22.1	7/0.40	27.2	40/0.2	0.8	7.4	72.1	880
150	3.0	740x0.5	23.9	7/0.40	39.6	40/0.2	0.8	7.8	77.9	1079
185	3.0	925x0.5	26.0	7/0.40	42.2	40/0.2	0.8	8.2	83.5	1251
240	3.0	1221x0.5	28.6	7/0.40	46.6	40/0.2	0.8	8.8	90.3	1502
Type 409.6										
16	5.0	126x0.4	16.5	7/0.25	17.2	24/0.2	0.8	6.4	57.3	440
25	5.0	209x0.4	18.0	7/0.25	18.6	24/0.2	0.8	6.7	61.2	516
35	5.0	285x0.4	19.3	7/0.25	18.6	24/0.2	0.8	7.0	64.6	584
50	5.0	380x0.4	20.8	7/0.25	21.3	40/0.2	0.8	7.3	68.5	669
70	5.0	361x0.5	22.8	7/0.25	23.4	40/0.2	0.8	7.7	73.7	804
95	5.0	475x0.5	24.0	7/0.25	29.2	40/0.2	0.8	8.1	77.8	934
120	5.0	608x0.5	26.1	7/0.30	31.7	40/0.2	0.8	8.5	83.1	1090
150	5.0	740x0.5	27.9	7/0.40	34.1	40/0.2	0.8	8.9	89.1	1310
185	5.0	925x0.5	30.0	7/0.40	47.5	40/0.2	0.8	9.3	94.5	1479
240	5.0	1221x0.5	32.6	7/0.40	52.8	40/0.2	0.8	9.9	101.4	1749
Type 409.11										
25	7.6	209x0.4	23.4	7/0.25	23.7	24/0.2	0.8	8.1	75.6	750
35	7.6	285x0.4	24.7	7/0.30	30.2	24/0.2	0.8	8.4	79.6	859
50	7.6	380x0.4	26.2	7/0.30	31.7	40/0.2	0.8	8.7	83.5	954

Nominal conductor area	Thickness of insulation	Number and nominal diameter of wires	Nominal diameter over insulation	Core screen size	Area of screen	Pilot cond. Strand/size	Thickness EPR covering	Nominal thickness of sheath	Nominal overall diameter	Approximate weight
mm ²	mm	n x mm	mm	mm	mm ²	No/mm	mm	mm	mm	kg/100 m
70	7.6	361x0.5	28.2	7/0.30	34.1	40/0.2	0.8	9.1	88.7	1105
95	7.6	475x0.5	29.4	7/0.40	47.5	40/0.2	0.8	9.6	93.6	1290
120	7.6	608x0.5	31.5	7/0.40	51.0	40/0.2	0.8	9.9	98.7	1460
150	7.6	740x0.5	33.3	7/0.40	53.7	40/0.2	0.8	10.3	103.4	1636
Type 409.22										
35	10.5	285x0.4	32.6	7/0.40	55.4	24/0.2	0.8	10.0	105.0	1405
50	10.5	380x0.4	34.1	7/0.40	58.1	40/0.2	0.8	10.3	108.8	1525

TYPE 440 1.1 to 22 kV

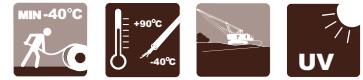

Flexible copper screened mining cable with three pilot core interstitial	
Standards: AS/NZS 2802: 2000	
CONSTRUCTION	
Conductors	Tinned annealed copper wires comply with AS/NZS 1125:2001 and AS/NZS 2802:2003
Separator/screen	For 1.1/1.1 kV paper separator. For other nominal voltages semi-conductive tape+ thermosetting compound over conductors
Insulation	Ethylene propylene rubber type R-EP-90
Insulation screen	Synthetic tape for voltage 1.1/1.1 kV or for voltage from 3.3/3.3 kV semi-conductive thermosetting compound+ tinned copper/polyamide braid comply to 12.4.1 AS/NZS 2802
Cable assembly	Three screened power and three pilot cores laid up with right hand direction on cradle separator
Sheath	Thermosetting compound HD-85-PCP - extra heavy duty, oil resistance and flame retardant
Standard marking	TF KABLE 3 R-EP-90 HD-85-PCP TYPE 440.1 (Year) (Size of power)
CHARACTERISTICS	
Excellent flexibility	
Water resistant and flame retardant	
Temperature range: -25°C to +90°C	
UV, sunlight, ozone and oil resistant	
Embossing printed for easy identification	
Application	For power supply to machinery and equipment For use where three pilot cores are required Larger cables for power supply to draglines, shovels and drills Smaller sizes used for drills, held hand tools and equipment Other industrial applications
Standard length cable packing	500 m on drums. Other forms of packing and delivery are available on request

Nominal conductor area	Thickness of insulation	Number and nominal diameter of wires	Nominal diameter over insulation	Core screen size	Area of screen	Pilot cond. Strand/size	Thickness EPR covering	Nominal thickness of sheath	Nominal overall diameter	Approximate weight
mm ²	mm	n x mm	mm	mm	mm ²	No/mm	mm	mm	mm	kg/100 m
Type 440.1-Class 2										
6	1.5	84x0.3	6.5	7/0.25	7.2	18/0.3	1.0	3.8	30.0	135
10	1.5	77x0.4	7.7	7/0.25	8.6	27/0.3	1.0	3.8	32.6	166
16	1.6	126x0.4	9.0	7/0.25	9.6	42/0.3	1.0	4.0	35.8	204
25	1.6	209x0.4	10.5	7/0.25	11.3	66/0.3	1.2	4.3	39.7	269
35	1.6	285x0.4	12.1	7/0.25	12.4	90/0.3	1.2	4.6	43.8	324
50	1.7	380x0.4	13.8	7/0.25	14.4	120/0.3	1.2	5.0	48.4	403
70	1.8	361x0.5	16.1	7/0.25	16.5	110/0.4	1.2	5.4	54.0	539
95	2.0	475x0.5	17.7	7/0.30	21.8	110/0.4	1.2	6.0	59.4	659
120	2.1	608x0.5	20.0	7/0.30	24.7	135/0.4	1.4	6.4	65.2	802
150	2.3	740x0.5	22.2	7/0.40	36.9	152/0.4	1.4	6.9	72.2	1018
185	2.5	925x0.5	24.7	7/0.40	40.5	177/0.4	1.4	7.4	78.8	1198
240	2.8	1221x0.5	27.9	7/0.50	57.7	216/0.4	1.6	8.2	88.7	1549
Type 440.3-Class 2										
16	3.0	126x0.4	12.5	7/0.25	13.1	42/0.3	1.4	5.3	46.1	304
25	3.0	209x0.4	14.0	7/0.25	14.8	66/0.3	1.4	5.6	50.0	379
35	3.0	285x0.4	15.3	7/0.25	15.8	90/0.3	1.4	5.9	53.4	446
50	3.0	380x0.4	16.8	7/0.25	17.2	120/0.3	1.4	6.3	57.5	524
70	3.0	361x0.5	20.0	7/0.25	18.6	110/0.4	1.4	6.6	62.4	659
95	3.0	475x0.5	22.1	7/0.25	20.3	110/0.4	1.6	7.1	66.2	754
120	3.0	608x0.5	23.9	7/0.30	27.2	135/0.4	1.6	7.4	71.9	914
150	3.0	740x0.5	26.0	7/0.40	39.6	152/0.4	1.6	7.8	77.9	1119
185	3.0	925x0.5	28.6	7/0.40	42.2	177/0.4	1.6	8.2	83.4	1289
240	3.0	1221x0.5	31.2	7/0.40	46.6	216/0.4	1.6	8.8	90.2	1559
Type 440.6-Class 2										
16	5.0	126x0.4	16.5	7/0.25	17.2	42/0.3	1.4	6.4	57.3	444
25	5.0	209x0.4	18.0	7/0.25	18.6	66/0.3	1.6	6.7	61.2	523
35	5.0	285x0.4	19.3	7/0.25	18.6	90/0.3	1.6	7.0	64.6	599
50	5.0	380x0.4	20.8	7/0.25	21.3	120/0.3	1.8	7.3	68.5	689
70	5.0	361x0.5	22.8	7/0.25	23.4	110/0.4	1.8	7.7	73.7	834
95	5.0	475x0.5	24.0	7/0.30	29.2	110/0.4	1.8	8.1	77.8	964
120	5.0	608x0.5	26.1	7/0.30	31.7	135/0.4	1.8	8.5	83.1	1119
150	5.0	740x0.5	27.9	7/0.40	45.7	152/0.4	1.8	8.9	89.1	1349
185	5.0	925x0.5	30.0	7/0.40	48.4	177/0.4	1.8	9.3	94.5	1529
Type 440.11-Class 2										
25	7.6	209x0.4	23.4	7/0.25	23.7	66/0.3	2.0	8.1	75.6	759
35	7.6	285x0.4	24.7	7/0.30	30.2	90/0.3	2.0	8.4	79.6	869
50	7.6	380x0.4	26.2	7/0.30	31.7	120/0.3	2.0	8.7	83.5	974
70	7.6	361x0.5	28.2	7/0.30	34.1	110/0.4	2.0	9.1	88.7	1139
95	7.6	475x0.5	29.4	7/0.40	47.5	110/0.4	2.2	9.6	93.6	1319

Nominal conductor area	Thickness of insulation	Number and nominal diameter of wires	Nominal diameter over insulation	Core screen size	Area of screen	Pilot cond. Strand/size	Thickness EPR covering	Nominal thickness of sheath	Nominal overall diameter	Approximate weight
mm ²	mm	n x mm	mm	mm	mm ²	No/mm	mm	mm	mm	kg/100 m
120	7.6	608x0.5	31.5	7/0.40	51.0	135x0.4	2.2	9.9	98.7	1489
150	7.6	740x0.5	33.3	7/0.40	53.7	152/0.4	2.2	10.3	103.4	1679
Type 440.22-Class 2										
35	10.5	285x0.4	32.6	7/0.40	55.4	90/0.3	2.5	10.0	104.9	1429
50	10.5	380x0.4	34.1	7/0.40	58.1	120/0.3	2.5	10.3	108.8	1549

TYPE 441 1.1 to 22 kV

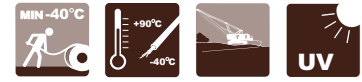

Flexible semi-conductive screened mining cable	
Standards: AS/NZS 2802: 2000	
CONSTRUCTION	
Conductors	Tinned annealed copper wires comply with AS/NZS 1125:2001 and AS/NZS 2802:2003
Separator/screen	For 1.1/1.1 kV paper separator. For other nominal voltages semi-conductive tape+ thermosetting compound over conductors
Insulation	Ethylene propylene rubber type R-EP-90 and XR-EP-90
Insulation screen	Synthetic tape for voltage 1.1/1.1 kV or for voltage from 3.3/3.3 kV semi-conductive thermosetting compound comply to AS/NZS 2802:2802
Cable assembly	Three screened power and three earth cores laid up with right hand direction on cradle separator with central pilot core
Internal sheath, earth covering, cradle separator	Semi-conductive thermosetting compound comply to AS/NZS 2802
Reinforcing braid	Polyamide yarns
Outer sheath	Thermosetting compound HD-90-CSP or XHD-90-CSP - extra heavy duty, oil resistance and flame retardant
Standard marking	TF KABLE 3 R-EP- 90/XHD-HD-90CSP TYPE 441.1 (Year) (Size of power)
CHARACTERISTICS	
Excellent flexibility	
Water resistant and flame retardant	
Temperature range: -25°C to +90°C	
UV, sunlight, ozone and oil resistant	
Embossing printed for easy identification	
Application	Semi-conductive screened cable for many uses For use where three earth/protecting and one pilot core are required Larger cables for power supply to draglines, shovels and drills Suitable for trailing and also for reeling applications Other industrial applications
Standard length cable packing	500 m on drums. Other forms of packing and delivery are available on request

Nominal conductor area	Thickness of insulation	Number and nominal diameter of wires	Nominal diameter over insulation	Core screen size	Area of screen	Pilot cond. Strand/size	Thickness EPR covering	Nominal thickness of sheath	Nominal overall diameter	Approximate weight
mm ²	mm	n x mm	mm	mm	mm ²	No/mm	mm	mm	mm	kg/100 m
Type 441.1-Class 2										
6	1.5	84x0.3	6.5	33/0.3	2.3	24/0.2	0.8	3.8	28.6	111
10	1.5	77x0.4	7.7	51/0.3	3.6	24/0.2	0.8	3.8	31.2	136
16	1.6	126x0.4	9.0	81/0.3	5.7	24/0.2	0.8	3.9	34.1	176
25	1.6	209x0.4	10.5	81/0.3	5.7	24/0.2	0.8	4.2	37.8	231
35	1.6	285x0.4	12.1	81/0.3	5.7	24/0.2	0.8	4.4	41.1	274
50	1.7	380x0.4	13.8	120/0.3	8.5	40/0.2	0.8	4.9	45.8	349
70	1.8	361x0.5	16.1	110/0.4	13.8	40/0.2	0.8	5.3	52.2	481
95	2.0	475x0.5	17.7	135/0.4	16.9	40/0.2	0.8	5.8	56.6	579
120	2.1	608x0.5	20.0	165/0.4	21.2	40/0.2	0.8	6.3	62.6	724
150	2.3	740x0.5	22.2	216/0.4	27.1	40/0.2	0.8	6.7	68.3	881
185	2.5	925x0.5	24.7	252/0.4	32.1	40/0.2	0.8	7.3	74.8	1049
240	2.8	1221x0.5	27.9	214/0.5	42.0	40/0.2	0.8	8.0	83.4	1329
300	3.0	1525/0.5	31.0	280/0.5	55.0	40/0.2	0.8	8.7	31.1	1629
Type 441.3-Class 1										
16	2.2	126x0.4	12.4	81/0.3	5.7	24/0.2	0.8	4.6	43.0	241
25	2.2	209x0.4	14.0	81/0.3	5.7	24/0.2	0.8	4.9	46.8	304
35	2.2	285x0.4	15.3	81/0.3	5.7	24/0.2	0.8	5.2	50.2	359
50	2.4	380x0.4	17.1	120/0.3	8.5	40/0.2	0.8	5.7	55.4	446
70	2.4	361x0.5	19.1	110/0.4	13.8	40/0.2	0.8	6.0	60.3	571
95	2.4	475x0.5	20.3	135/0.4	16.9	40/0.2	0.8	6.4	63.5	659
120	2.4	608x0.5	22.4	165/0.4	21.2	40/0.2	0.8	6.5	68.5	794
150	2.4	740/0.5	24.2	216/0.4	27.1	40/0.2	0.8	6.6	72.6	931
185	2.4	925x0.5	26.3	252/0.4	32.1	40/0.2	0.8	6.7	77.4	1080
240	2.4	1221x0.5	28.9	214/0.5	42.0	40/0.2	0.8	6.9	83.3	1310
300	2.4	1525x0.5	31.5	280/0.5	55.0	40/0.2	0.8	7.0	89.2	1570
Type 441.6-Class 1										
16	3.0	126x0.4	14.0	81/0.3	5.7	24/0.2	0.8	5.0	47.4	241
25	3.0	209x0.4	15.5	81/0.3	5.7	24/0.2	0.8	5.3	51.2	304
35	3.0	285x0.4	16.8	81/0.3	5.7	24/0.2	0.8	5.6	54.7	359
50	3.0	380x0.4	18.3	120/0.3	8.5	40/0.2	0.8	6.0	58.8	446
70	3.0	361x0.5	19.1	110/0.4	13.8	40/0.2	0.8	6.3	63.8	571
95	3.0	475x0.5	20.3	135/0.4	16.9	40/0.2	0.8	6.4	66.4	659
120	3.0	608x0.5	21.5	165/0.4	21.2	40/0.2	0.8	6.6	71.3	794
150	3.0	740x0.5	23.6	216/0.4	27.1	40/0.2	0.8	6.7	75.4	931
185	3.0	925x0.5	25.4	252/0.4	32.1	40/0.2	0.8	6.8	80.1	1080
240	3.0	1221x0.5	27.5	214/0.5	42.0	40/0.2	0.8	7.0	86.1	1310
300	3.0	1525x0.5	30.1	280/0.5	55.0	40/0.2	0.8	7.1	91.9	1570
Type 441.11-Class 1										
25	5.0	209x0.4	19.6	81/0.3	5.7	24/0.2	0.8	6.3	62.1	481

Nominal conductor area	Thickness of insulation	Number and nominal diameter of wires	Nominal diameter over insulation	Core screen size	Area of screen	Pilot cond. Strand/size	Thickness EPR covering	Nominal thickness of sheath	Nominal overall diameter	Approximate weight
mm ²	mm	n x mm	mm	mm	mm ²	No/mm	mm	mm	mm	kg/100 m
35	5.0	285x0.4	20.8	81/0.3	5.7	24/0.2	0.8	6.4	65.1	542
50	5.0	380x0.4	22.4	120/0.3	8.5	40/0.2	0.8	6.5	68.7	620
70	5.0	361x0.5	24.4	110/0.4	13.8	40/0.2	0.8	6.6	63.8	750
95	5.0	475x0.5	25.6	135/0.4	16.9	40/0.2	0.8	6.8	73.0	850
120	5.0	608x0.5	27.7	165/0.4	21.2	40/0.2	0.8	6.9	76.2	986
150	5.0	740x0.5	29.5	216/0.4	27.1	40/0.2	0.8	7.0	80.8	1129
185	5.0	925x0.5	31.6	252/0.4	32.1	40/0.2	0.8	7.1	85.0	1289
240	5.0	1221x0.5	34.2	214/0.5	42.0	40/0.2	0.8	7.3	89.6	1539
Type 441.22-Class 1										
35	7.6	285x0.4	26.3	81/0.3	5.7	24/0.2	0.8	6.9	78.0	733
50	7.6	380x0.4	27.8	120/0.3	8.5	40/0.2	0.8	7.0	81.5	820
70	7.6	361x0.5	29.8	110/0.4	13.8	40/0.2	0.8	7.1	85.9	960
95	7.6	475x0.5	31.0	135/0.4	16.9	40/0.2	0.8	7.2	88.7	1070
120	7.6	608x0.5	33.1	165/0.4	21.2	40/0.2	0.8	7.3	93.6	1220
150	7.6	740x0.5	34.9	216/0.4	27.1	40/0.2	0.8	7.4	97.6	1380
185	7.6	925x0.5	37.0	252/0.4	32.1	40/0.2	0.8	7.6	102.6	1545

Committed
to
innovation



TYPE 450 3.3 to 33 kV

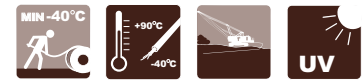

Flexible copper screened mining cable with two earth and one pilot core	
Standards: AS/NZS 2802: 2000	
CONSTRUCTION	
Conductors	Tinned annealed copper wires comply with AS/NZS 1125:2001 and AS/NZS 2802:2003
Conductor screen	Semi-conductive tape+ thermosetting compound over conductors
Insulation	Ethylene propylene rubber type XR-EP-90
Insulation screen	Semi-conductive thermosetting compound+ tinned copper/polyamide braid comply to 12.4.1 AS/NZS 2802
Cable assembly	Three screened power, two earth and one pilot core laid up with right hand direction on the rubber centre filler
Sheath	Double layer thermosetting compound HD-85-PCP - extra heavy duty, oil resistance and flame retardant. An open braid of polyamide yarns between layer of rubber
Standard marking	TF KABLE 3 XR-EP/90 HD-90CSP TYPE 450.3 (Year) (Size of power)
CHARACTERISTICS	
Excellent flexibility	
Water resistant and flame retardant	
Temperature range: -25°C to +90°C	
UV, sunlight, ozone and oil resistant	
Embossing printed for easy identification	
Application	For power supply to a wide range applications For use where two earth and one pilot cores are required For power supply to draglines and slow reeling applications where copper screened cables are required Other industrial applications
Standard length cable packing	500 m on drums. Other forms of packing and delivery are available on request

Nominal conductor area	Thickness of insulation	Number and nominal diameter of wires	Nominal diameter over insulation	Core screen size	Area of screen	Pilot cond. Strand/size	Thickness EPR covering	Nominal thickness of sheath	Nominal overall diameter	Approximate weight
mm ²	mm	n x mm	mm	mm	mm ²	No/mm	mm	mm	mm	kg/100 m
Type 450.3-Class 1										
16	2.2	126x0.4	12.4	128/0.25	6.3	120/0.3	1.4	4.5	42.8	266
25	2.2	209x0.4	14.0	118/0.3	8.3	120/0.3	1.4	4.8	46.9	338
35	2.2	285x0.4	15.2	127/0.3	9.0	120/0.3	1.4	5.1	50.4	392
50	2.4	380x0.4	17.1	141/0.3	10.0	180/0.3	1.4	5.6	55.7	487
70	2.4	361x0.5	19.1	117/0.4	14.7	152/0.4	1.4	6.0	61.3	637
95	2.4	475x0.5	20.3	123/0.4	15.5	196/0.4	1.6	6.3	64.5	734
120	2.4	608x0.5	22.4	135/0.4	17.0	236/0.4	1.6	6.4	69.2	867
150	2.4	740x0.5	24.2	144/0.4	18.1	314/0.4	1.6	6.6	73.5	1022
185	2.4	925x0.5	26.3	144/0.4	26.7	237/0.4	1.6	6.7	78.3	1175
240	2.4	1221x0.5	28.9	136/0.5	28.3	302/0.5	1.6	6.9	84.7	1741
Type 450.6-Class 1										
16	3.0	126x0.4	12.4	118/0.3	8.3	120/0.3	1.4	5.0	47.7	317
25	3.0	209x0.4	14.0	129/0.3	9.1	120/0.3	1.6	5.2	51.3	382
35	3.0	285x0.4	15.2	139/0.3	9.8	120/0.3	1.6	5.5	54.8	443
50	3.0	380x0.4	17.1	149/0.3	10.5	177/0.3	1.6	5.9	58.9	534
70	3.0	361x0.5	19.1	123/0.4	15.5	152/0.4	1.6	6.3	64.3	682
95	3.0	475x0.5	20.3	130/0.4	16.3	196/0.4	1.8	6.4	67.1	771
120	3.0	608x0.5	22.4	141/0.4	17.7	236/0.4	1.8	6.5	71.9	912
150	3.0	740x0.5	24.2	144/0.4	18.1	314/0.4	1.8	6.6	76.2	1073
185	3.0	925x0.5	26.3	144/0.4	18.1	237/0.5	1.8	6.8	81.0	1222
240	3.0	1221/0.5	28.9	144/0.5	27.7	302/0.5	1.8	7.0	87.5	1502
Type 450.11-Class 1										
25	5.0	209x0.4	19.6	120/0.4	15.1	120/0.3	2.0	6.3	62.8	542
35	5.0	285x0.4	20.9	127/0.4	16.0	120/0.3	2.0	6.4	65.8	601
50	5.0	380x0.4	22.4	135/0.4	17.0	177/0.3	2.0	6.5	69.4	692
70	5.0	361x0.5	24.4	144/0.4	18.1	152/0.4	2.0	6.6	73.9	826
95	5.0	475x0.5	25.6	144/0.4	18.1	196/0.4	2.2	6.7	76.7	926
120	5.0	608x0.5	27.7	144/0.5	18.1	236/0.4	2.2	6.9	81.8	1082
150	5.0	740x0.5	29.5	139/0.5	27.3	314/0.4	2.2	7.0	86.2	1263
185	5.0	925x0.5	31.6	144/0.5	28.3	237/0.5	2.2	7.1	90.9	1433
240	5.0	1221/0.5	34.2	144/0.5	28.3	302/0.5	2.2	7.3	96.8	1695
Type 450.22-Class 2										
35	7.6	285x0.4	26.3	144/0.4	18.1	120/0.3	2.5	6.8	78.5	601
50	7.6	380x0.4	27.8	144/0.4	18.1	183/0.3	2.5	6.9	81.8	692
70	7.6	361x0.5	29.8	140/0.5	27.5	152/0.4	2.5	7.0	86.9	826
95	7.6	475x0.5	31.0	144/0.5	28.3	196/0.4	2.5	7.2	89.9	926
120	7.6	608x0.5	33.1	144/0.5	28.3	236/0.4	2.5	7.3	94.7	1082
150	7.6	740x0.5	34.9	144/0.5	28.3	314/0.4	2.5	7.4	104.4	1263
Type 450.33-Class 2										

Nominal conductor area	Thickness of insulation	Number and nominal diameter of wires	Nominal diameter over insulation	Core screen size	Area of screen	Pilot cond. Strand/size	Thickness EPR covering	Nominal thickness of sheath	Nominal overall diameter	Approximate weight
mm ²	mm	n x mm	mm	mm	mm ²	No/mm	mm	mm	mm	kg/100 m
50	10.5	380x0.4	34.1	144/0.5	28.3	183/0.3	2.5	7.4	96.9	1222
70	10.5	361x0.5	36.1	144/0.5	28.3	152/0.4	2.5	7.5	101.4	1385
95	10.5	475x0.5	37.3	144/0.5	28.3	196/0.4	2.5	7.7	104.4	1505

TYPE 455 3.3 to 33 kV

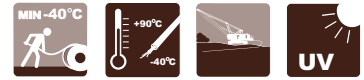
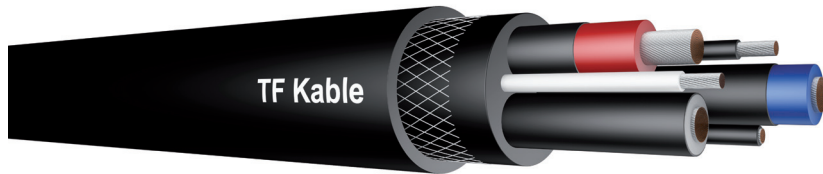

Flexible semi-conductive screened mining cable with two earth and one pilot core	
Standards: AS/NZS 2802: 2000	
CONSTRUCTION	
Conductors	Tinned annealed copper wires comply with AS/NZS 1125:2001 and AS/NZS 2802:2003
Conductor screen	Semi-conductive tape+ thermosetting compound over conductors
Insulation	Ethylene propylene rubber type XR-EP-90
Insulation screen	Semi-conductive thermosetting compound comply to 12.4.1 AS/NZS 2802
Cable assembly	Three screened power, two earth and one pilot core laid up with right hand direction on the rubber centre filler
Internal sheath, earth covering	Semi-conductive thermosetting compound comply to AS/NZS 2802:2003
Reinforcing braid	Polyamide yarns
Outer sheath	Thermosetting compound XHD-90-CSP - extra heavy duty, oil resistance and flame retardant
Standard marking	TF KABLE 3 XR-EP/90 XHD-90CSP TYPE 455.3 (Year) (Size of power)
CHARACTERISTICS	
Excellent flexibility	
Water resistant and flame retardant	
Temperature range: -25°C to +90°C	
UV, sunlight, ozone and oil resistant	
Embossing printed for easy identification	
Application	Particulary suited to stacker-reclaimer applications Suitable for reeling and trailing applications For use where two earth and one pilot cores are required Other industrial applications
Standard length cable packing	500 m on drums. Other forms of packing and delivery are available on request

Nominal conductor area	Thickness of insulation	Number and nominal diameter of wires	Nominal diameter over insulation	Pilot cond. Strand/size	Thickness of earth covering	Nominal thickness of sheath	Nominal overall diameter	Approximate weight
mm ²	mm	n x mm	mm	No/mm	mm	mm	mm	kg/100 m
Type 455.3-Class 1								
16	2.2	126x0.4	12.4	120/0.3	1.4	4.2	39.5	224
25	2.2	209x0.4	14.0	120/0.3	1.4	4.5	43.4	281
35	2.2	285x0.4	15.2	120/0.3	1.4	4.8	46.8	336
50	2.4	380x0.4	17.1	180/0.3	1.4	5.3	52.0	424
70	2.4	361x0.5	19.1	152/0.4	1.4	5.7	57.0	556
95	2.4	475x0.5	20.3	196x0.4	1.6	6.1	60.5	646
120	2.4	608x0.5	22.4	236/0.4	1.6	6.4	65.6	786
150	2.4	740x0.5	24.2	314/0.4	1.6	6.5	69.6	931
185	2.4	925x0.5	26.3	237/0.4	1.6	6.6	74.5	1072
240	2.4	1221x0.5	28.9	302/0.5	1.6	6.8	80.4	1310
300	2.4	1525x0.5	31.5	409/0.5	1.6	6.9	86.2	1602
Type 455.6-Class 1								
16	3.0	126x0.4	14.0	120/0.3	1.4	4.7	44.0	266
25	3.0	209x0.4	15.5	120/0.3	1.6	5.0	47.9	332
35	3.0	285x0.4	16.8	120/0.3	1.6	5.3	51.4	387
50	3.0	380x0.4	18.3	177/0.3	1.6	5.6	55.1	466
70	3.0	361x0.5	20.3	152/0.4	1.6	6.0	60.2	597
95	3.0	475x0.5	21.5	196/0.4	1.8	6.3	63.4	692
120	3.0	608x0.5	23.6	236/0.4	1.8	6.5	68.4	826
150	3.0	740x0.5	25.4	314/0.4	1.8	6.6	72.5	977
185	3.0	925x0.5	27.5	237/0.5	1.8	6.7	77.2	1122
240	3.0	1221/0.5	30.1	302/0.5	1.8	6.9	83.2	1361
300	3.0	1525/0.5	32.7	409/0.5	1.8	7.0	89.0	1652
Type 455.11-Class 1								
16	5.0	126/0.4	12.4	120/0.3	2.0	5.8	55.0	392
25	5.0	209x0.4	19.6	120/0.3	2.0	6.1	59.1	462
35	5.0	285x0.4	20.9	120/0.3	2.0	6.3	62.4	527
50	5.0	380x0.4	22.4	177/0.3	2.0	6.4	65.7	607
70	5.0	361/0.5	24.4	152/0.4	2.0	6.5	70.2	742
95	5.0	475x0.5	25.6	196/0.4	2.2	6.7	73.4	837
120	5.0	608x0.5	27.7	236/0.4	2.2	6.8	78.0	982
150	5.0	740x0.5	29.5	314/0.4	2.2	6.9	82.1	1143
185	5.0	925x0.5	31.6	237/0.5	2.2	7.0	86.9	1305
240	5.0	1221/0.5	34.2	302/0.5	2.2	7.2	92.9	1553
Type 455.22-Class 1								
16	7.6	126x0.4	23.5	120/0.3	2.5	6.6	68.5	578
25	7.6	209x0.4	25.0	120/0.3	2.5	6.6	71.7	653
35	7.6	285x0.4	26.3	120/0.3	2.5	6.7	74.8	719
50	7.6	380x0.4	27.8	183/0.3	2.5	6.8	78.3	810
70	7.6	361x0.5	29.8	152/0.4	2.5	7.0	83.0	956

Nominal conductor area	Thickness of insulation	Number and nominal diameter of wires	Nominal diameter over insulation	Pilot cond. Strand/size	Thickness of earth covering	Nominal thickness of sheath	Nominal overall diameter	Approximate weight
mm ²	mm	n x mm	mm	No/mm	mm	mm	mm	kg/100 m
95	7.6	475x0.5	31.0	196/0.4	2.5	7.1	85.8	1061
120	7.6	608x0.5	33.1	236/0.4	2.5	7.2	90.6	1221
150	7.6	740x0.5	34.9	314/0.4	2.5	7.3	94.7	1392
185	7.6	925/0.5	37.0	237/0.5	2.5	7.4	99.2	1564
Type 455.33-Class 1								
16	10.5	126x0.4	120/0.3	120/0.3	2.5	7.0	83.0	822
25	10.5	209x0.4	120/0.3	120/0.3	2.5	7.1	86.4	920
35	10.5	285x0.4	120/0.3	120/0.3	2.5	7.2	89.4	993
50	10.5	380x0.4	34.1	183/0.3	2.5	7.3	92.8	1092
70	10.5	361x0.5	36.1	152/0.4	2.5	7.4	97.4	1254
95	10.5	475x0.5	37.3	196/0.4	2.5	7.6	100.5	1372
120	10.5	608x0.5	39.4	236/0.4	2.5	7.7	105.2	1543

TYPE 2S 0.6/1 kV

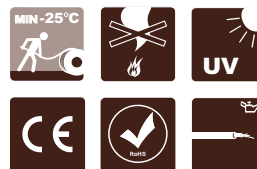

Wiring machine, screened, rubber insulated and sheathed cable	
Standards: AS/NZS 1972: 2006	
CONSTRUCTION	
Conductors	Flexible tinned annealed copper wires comply with AS/NZS 1125
Separator	If needed a suitable tape separator between the conductor and insulation
Insulation	Ethylene-propylene compound type R-EP-90
Circuit identification	Cores identification in accordance with AS 1979
Outer jacket	Synthetic CPE compound equivalent HD-90-CPE
Colour of outer jacket	Black
Standard marking	TF KABLE 3, Type 2S (Size) (Year) (Metric scale)
CHARACTERISTICS	
Halogen free, flame retardant	
Temperature range -25°C to +60°C	
UV, sunlight and ozone resistant	
Ink jet printed for easy identification	
Application	For general use in domestic premises, kitchens, offices and for supplying appliances where the cables are subjected to low mechanical stresses (eg. vacuum cleaners, cooking appliances, soldering irons, toasters) Other industrial applications
Standard length cable packing	1000 m on drums. Other forms of packing and delivery are available on request

Size	Insulation thickness	Tape of screen	Sheath thickness (mm)			
			2-core	3-core	4-core	6-core
mm ²	mm					
1.5	0.8	Collective	1.8	1.8	1.8	1.8
2.5	1.0	Collective	1.8	1.8	1.8	1.8
4	1.0	Collective	1.8	1.8	1.8	1.8
6	1.0	Collective	1.8	1.8	1.8	1.8
10	1.0	Collective	1.8	1.8	1.8	1.8
16	1.0	Collective	1.8	1.8	1.8	1.8
25	1.2	Collective	1.8	1.8	1.8	1.9
35	1.2	Collective	1.8	1.8	1.8	-
50	1.4	Collective	1.8	1.9	2.0	-
70	1.4	Collective	1.9	2.0	2.1	-
95	1.6	Collective	2.1	2.2	2.3	-
1.5	0.8	Individual	1.8	1.8	1.8	1.8
2.5	1.0	Individual	1.8	1.8	1.8	1.8
4	1.0	Individual	1.8	1.8	1.8	1.8
6	1.0	Individual	1.8	1.8	1.8	1.8
10	1.0	Individual	1.8	1.8	1.8	1.8
16	1.0	Individual	1.8	1.8	1.8	1.8
25	1.2	Individual	1.8	1.8	1.8	1.9
35	1.2	Individual	1.8	1.8	1.8	-
50	1.4	Individual	1.8	1.9	2.0	-
70	1.4	Individual	2.0	2.0	2.1	-
95	1.6	Individual	2.1	2.2	2.3	-

Number of cores x size	Insulation thickness	Tape of screen	Sheath thickness (mm)
n x mm ²	mm		mm
16x1.5	0.8	Collective	1.8
30x1.5	0.8	Collective	1.8
16x1.5	0.8	Individual	1.8
30x1.5*	0.8	Individual	1.9
30x2.5	0.8	Individual	2.0

* Approximate overall diameter - 32.6

Size	Max. resistance		Capacitance	Rating current			
	DC 20°C	AC 90°C		2-core	3-core	4-core	6 core
mm ²	Ω/km		μF/km	A			
Collectively screened							
1.5	13.7	17.5	0.159	20	20	20	20
2.5	8.21	10.5	0.192	32	27	27	24
4	5.09	6.49	0.224	45	39	39	31
6	3.39	4.32	0.271	57	48	48	39
10	1.95	2.49	0.332	80	67	67	53
16	1.24	1.58	0.394	106	89	89	72

Size	Max. resistance		Capacitance	Rating current			
	DC 20°C	AC 90°C		2-core	3-core	4-core	6 core
mm ²	Ω/km		μF/km	A			
25	0.795	1.01	0.409	141	119	119	96
35	0.565	0.72	0.470	174	147	147	-
50	0.393	0.50	0.484	218	185	185	-
70	0.277	0.35	0.562	272	230	230	-
95	0.210	0.27	0.571	323	271	271	-
Individually screened							
1.5	13.7	17.5	0.223	20	20	20	20
2.5	8.21	10.5	0.275	32	27	27	24
4	5.09	6.49	0.326	45	39	39	31
6	3.39	4.32	0.403	57	48	48	39
10	1.95	2.49	0.504	80	67	67	53
16	1.24	1.58	0.605	106	89	89	72
25	0.795	1.01	0.621	141	119	119	96
35	0.565	0.721	0.719	174	147	147	-
50	0.393	0.502	0.735	218	185	185	-
70	0.277	0.354	0.860	272	230	230	-
95	0.210	0.269	0.867	323	271	271	-

Size	Inductance				Reactance				Impedance at 90°C			
	2-core	3-core	4-core	6-core	2-core	3-core	4-core	6-core	2-core	3-core	4-core	6-core
mm ²	mH/km				Ω/km				Ω/km			
Collectively screened												
1.5	0.338	0.338	0.404	0.470	0.106	0.106	0.127	0.148	17.5	17.5	17.5	17.5
2.5	0.310	0.310	0.370	0.431	0.097	0.097	0.116	0.135	10.5	10.5	10.5	10.5
4	0.291	0.291	0.347	0.404	0.091	0.091	0.109	0.127	6.49	6.49	6.49	6.49
6	0.271	0.271	0.324	0.377	0.085	0.085	0.102	0.118	4.32	4.32	4.32	4.32
10	0.255	0.255	0.304	0.354	0.080	0.080	0.096	0.111	2.49	2.49	2.49	2.49
16	0.244	0.244	0.291	0.339	0.077	0.077	0.091	0.106	1.58	1.58	1.58	1.58
25	0.242	0.242	0.290	0.337	0.076	0.076	0.091	0.106	1.02	1.02	1.02	1.02
35	0.235	0.235	0.281	-	0.074	0.074	0.088	-	0.725	0.725	0.726	-
50	0.234	0.234	0.280	-	0.073	0.073	0.088	-	0.507	0.507	0.509	-
70	0.227	0.227	0.272	-	0.071	0.071	0.085	-	0.361	0.361	0.364	-
95	0.227	0.227	0.271	-	0.071	0.071	0.085	-	0.278	0.278	0.282	-
Individually screened												
1.5	0.399	0.399	0.501	0.598	0.125	0.125	0.157	0.188	17.5	17.5	17.5	17.5
2.5	0.364	0.364	0.456	0.545	0.114	0.114	0.143	0.171	10.5	10.5	10.5	10.5
4	0.339	0.339	0.425	0.508	0.106	0.106	0.134	0.159	6.49	6.49	6.49	6.49
6	0.313	0.313	0.393	0.469	0.098	0.098	0.123	0.147	4.32	4.32	4.32	4.33
10	0.290	0.290	0.364	0.434	0.091	0.091	0.114	0.136	2.49	2.49	2.49	2.49
16	0.274	0.274	0.344	0.411	0.086	0.086	0.108	0.129	1.58	1.58	1.58	1.59
25	0.267	0.267	0.335	0.401	0.084	0.084	0.105	0.126	1.02	1.02	1.02	1.02
35	0.257	0.257	0.323	-	0.081	0.081	0.101	-	0.725	0.725	0.728	-

Size	Inductance				Reactance				Impedance at 90°C			
	2-core	3-core	4-core	6-core	2-core	3-core	4-core	6-core	2-core	3-core	4-core	6-core
mm ²	mH/km				Ω/km				Ω/km			
50	0.253	0.253	0.317	-	0.079	0.079	0.100	-	0.508	0.508	0.512	-
70	0.244	0.244	0.306	-	0.077	0.077	0.096	-	0.362	0.362	0.367	-
95	0.241	0.241	0.303	-	0.076	0.076	0.095	-	0.280	0.280	0.285	-

Number of cores x size	Max. resistance DC at 20°C		Capacitance	Rating current	Inductance	Reactance	Impedance at 90°C
n x mm ²	Ω/km		μF/km	A	mH/km	Ω/km	Ω/km
Collectively screened							
16x1.5	13.7	17.5	0.159	20	0.587	0.184	17.5
30x1.5	13.7	17.5	0.159	20	0.660	0.207	17.5
Individually screened							
16x1.5	13.7	17.5	0.223	20	0.587	0.218	17.5
30x1.5	13.7	17.5	0.223	20	0.660	0.245	17.5

Quality
takes
priority



MINING TELECOMMUNICATION CABLES

TCEKEY	158
TCEKFY	160
TCEKFLEY	162
TCEPKPFLEY	164
TCEKFLEDY	166
YnTKGMLY TEX	168
YnTKGX	169
4GTL3Gekwn-G	170
YTKGXFoyn, YTKGXFtlyn, YTKGXFtyn	172
YOTKGtsDFoyn	174
YOTKGtsFoyn	176
YOTKGtsDFtlyn	178
ZW-(QG)GNOTKSdD	179
PSKD	181
YOTKGtsFtlyn	183

TCEKEY

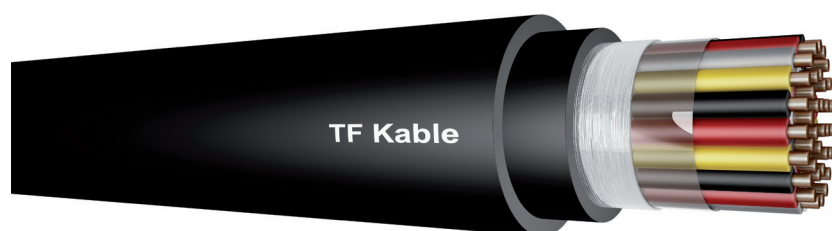

Telecommunication cable					
Standards: TT1-5497					
CONSTRUCTION					
Conductors	Single copper wire				
Diameter of conductor	0.4; 0.6; 0.8 mm				
Insulation	Polyethylene				
Bundle	2 pairs of the insulated wires stranded into quad, 5 quads in a bundle				
Identification of pair in bundles	First pair	Second pair			
	Quad	Wire a	Wire b	Wire a	Wire b
	1	red	white	grey	violet
	2	green	white	grey	violet
	3	blue	white	grey	violet
	4	brown	white	grey	violet
5	orange	white	grey	violet	
spare quad	black	white	grey	violet	
Number of quads in a base unit	5				
Identification of bundles in a base unit	1 st bundle in a unit: red 2 nd bundle in a unit: green Rest of bundles in a unit: white				
Number of quads in a main unit	25 or 50				
Cable core	Stranded bundles wrapped with a polyester tape				
Bundle arrangement in the cable core	No. of quads	Arrangement			
	Nominal	Real (nominal+spare)	Core	1 st layer	
	1	1	1	-	
	3	3	3	-	
	5	5	5	-	
	10	10	2x5	-	
	15	15	3x5	-	
	20	21	4x5+1	-	
	25	26	5x5+1	-	
	35	36	1x5+1	6x5	
	50	51	3x5+1	7x5	
	75	76	2x25+1x26	-	
	100	102	2x25+2x26	-	
	150	153	1x25	2x25+3x26	
200	204	2x25	2x25+3x26		
250	256	2x25+1x26	2x25+5x26		
300	306	1x51	5x51		
400	408	2x51	6x51		
500	510	3x51	7x51		
Screen	Laminated Al tape				
Filling	Petro-jelly				
Drain wire	Tinned copper wire: 0.5 mm				
Inner sheath	LDPE, black				
Colour of the inner sheath	Black				
Outer sheath	PVC				
Colour of the outer sheath	Black				

CHARACTERISTICS	
Loop resistance	ø Cu 0.4 mm: max. 300 Ω/km ø Cu 0.6 mm: max. 133.2 Ω/km ø Cu 0.8 mm: max. 73.6 Ω/km
Mutual capacitance	Average: 42 µF/km Bundle: 46 µF/km
Insulation resistance min. 5GΩ/km	
Capacitance unbalance K1	95% of values <500 pF/500 m max. 800 pF/500 m
Minimum bending radius: 15 x D, D - overall diameter of cable	
Production length: 600 m in case of: cables up to 100 quads and ø Cu 0.4 mm cables up to 50 quads and ø Cu 0.6 mm cables up to 35 quads and ø Cu 0.8 mm 300 m for other constructions	
Application	Designed for telecommunication networks

Cable construction	Nominal thickness of the inner and outer sheath		
	Conductor diameter		
	0.4	0.6	0.8
	mm		
1x4	1.4	1.4	1.4
3x4	1.4	1.4	1.4
5x4	1.4	1.4	1.4
10x4	1.4	1.4	1.4
15x4	1.4	1.4	1.6
20x4	1.4	1.6	1.6
25x4	1.4	1.6	1.6
35x4	1.6	1.8	2.0
50x4	1.6	1.8	2.0
75x4	1.8	2.0	2.2
100x4	1.8	2.0	2.2
150x4	1.8	2.2	-
200x4	2.0	2.4	-
250x4	2.2	2.6	-
300x4	2.2	-	-
400x4	2.4	-	-
500x4	2.4	-	-

TCEKFY

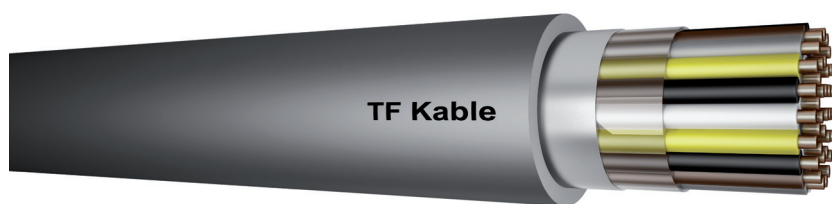

Telecommunication cable					
Standards: TT1-5519					
CONSTRUCTION					
Conductors	Single copper wire				
Diameter of conductor	1.0 mm				
Identification of pair in bundles	Pair marker reference odd even	Wire a red green blue brown	Wire b white white white white		
Cable core	Pairs stranded into layers; each layer wrapped with a polyester tape				
Layer of identification	Layer core 1 st 2 nd	Tape colour red green blue			
Pair arrangement in the cable core	No. of pairs	Core	1 st layer	2 nd layer	3 rd layer
	1	1	-	-	-
	2	2	-	-	-
	3	3	-	-	-
	4	4	-	-	-
	6	6	-	-	-
	7	1	1	-	-
	12	3	3	-	-
	16	4	12	-	-
	24	2	8	14	-
	30	4	10	16	-
	48	3	9	15	-
Drain wire	Tinned copper wire: 0.8 mm				
Screen	Laminated Al tape				
Colour of the inner sheath	Black				
Outer sheath	PVC				
Colour of the outer sheath	Black				
CHARACTERISTICS					
Loop resistance: max. 50 Ω/km					
Resistance of insulation: min. 5000 MΩ/km					
Mutual capacitance is 60 µF/km					
Minimum bending radius: 10 x D, D - overall diameter of cable					
Production length: 600 m in case of: cables up to 100 quads and ø Cu 0.4 mm cables up to 50 quads and ø Cu 0.6 mm cables up to 35 quads and ø Cu 0.8 mm 300 m for other constructions					
Application	Designed for telecommunication networks				

Number of pairs in a cable	Number of pairs in the 1 st layer	Number of pairs in the 2 nd layer	Number of pairs in the 3 rd layer	Number of pairs in the 4 th layer
5	5	-	-	-
10	2	8	-	-
16	5	11	-	-
24	2	8	14	-
33	5	11	17	-
56	5	11	17	23
60	6	12	18	23

Cable construction	Inner sheath thickness	Outer sheath thickness	Diameter of steel wires	Steel wire thickness	Outer diameter
mm					
5x2	1.4+/-0.1	1.5+/-0.2	1.4	0.3	14.1
10x2	1.4+/-0.1	1.5+/-0.2	1.4	0.3	17.1
16x2	1.4+/-0.1	1.6+/-0.2	1.8	0.3	19.5
24x2	1.4+/-0.1	1.6+/-0.2	1.8	0.3	21.8
33x2	1.6+/-0.1	1.7+/-0.2	1.8	0.3	24.4
56x2	1.6+/-0.1	1.8+/-0.2	1.8	0.5	30.1
60x2	1.6+/-0.1	1.9+/-0.2	1.8	0.5	32.2

TCEKFLEY

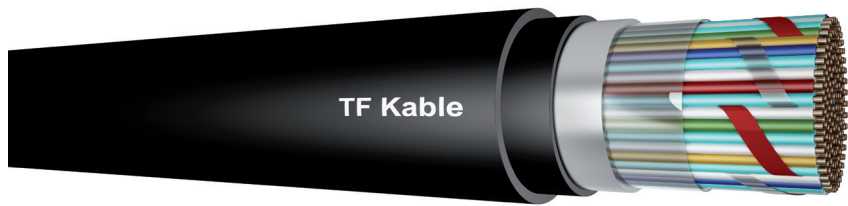

Telecommunication cable					
Standards: TT1-5472					
CONSTRUCTION					
Conductors	Single copper wire				
Diameter of conductor	0.4; 0.6; 0.8 mm				
Insulation	Polyethylene				
Bundle	2 pairs of the insulated wires stranded into quad, 5 quads in a bundle				
Identification of pair in bundles	First pair		Second pair		
	Quad	Wire a	Wire b	Wire a	Wire b
	1	red	white	grey	violet
	2	green	white	grey	violet
	3	blue	white	grey	violet
	4	brown	white	grey	violet
	5	orange	white	grey	violet
spare quad	black	white	grey	violet	
control conductors	red	white			
Cable core	Stranded bundles wrapped with a polyester tape				
Bundle arrangement in the cable core	No. of quads		Arrangement		
	Nominal	Real (nominal+spare)	Core	1 st layer	
	1	1	1	-	
	3	3	3	-	
	5	5	5	-	
	10	10	2x5	-	
	15	15	3x5	-	
	20	21	4x5+1	-	
	25	26	5x5+1	-	
	35	36	1x5+1	6x5	
50	51	3x5+1	7x5		
75	76	2x25+1x26	-		
100	102	2x25+2x26	-		
Water barrier	One-side laminated aluminium tape				
Drain wire	Tinned copper wire				
Inner sheath	Polyethylene, black				
Colour of the inner sheath	Black				
Outer sheath	PVC				
Colour of the outer sheath	Black				

CHARACTERISTICS	
Loop resistance	ø Cu 0.4 mm: max. 300 Ω/km ø Cu 0.6 mm: max. 133.2 Ω/km ø Cu 0.8 mm: max. 73.6 Ω/km
Mutual capacitance	Average: 42 µF/km Bundle: 46 µF/km
Insulation resistance min. 5GΩ/km	
Capacitance unbalance	ø Cu 0.4; 0.6 mm 95% of values <150 pF/500 m max. 250 pF/500 m
	ø Cu 0.8 mm 95% of values <100 pF/500 m max. 160 pF/500 m
Minimum bending radius: 10 x D, D - overall diameter of cable	
Production length: 600 m in case of: cables up to 100 quads and ø Cu 0.4 mm cables up to 50 quads and ø Cu 0.6 mm cables up to 35 quads and ø Cu 0.8 mm 300 m for other constructions	
Application	Designed for telecommunication networks

Cable construction	Nominal thickness of the inner and outer sheath			Min. thickness of the outer sheath
	Conductor diameter			
	0.4	0.6	0.8	
	mm			
1x4	1.4	1.4	1.5	2.0
3x4	1.6	1.6	1.6	2.0
5x4	1.6	1.6	1.8	2.0
10x4	1.6	1.8	1.8	2.0
15x4	1.8	1.8	1.8	2.0
20x4	1.8	1.8	2.0	2.0
25x4	1.8	2.0	2.0	2.0
35x4	1.8	2.0	2.2	2.0
50x4	2.0	2.0	2.2	2.0
100x4	2.0	2.0	2.2	2.0

TCEPKPKFLEY

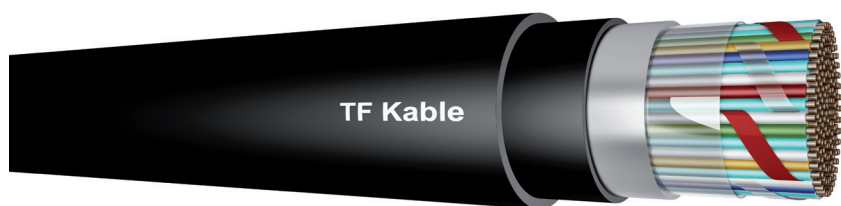

Telecommunication cable					
Standards: TT1-5497					
CONSTRUCTION					
Conductors	Single copper wire				
Diameter of conductor	0.4; 0.6; 0.8 mm				
Insulation	Polyethylene				
Bundle	2 pairs of the insulated wires stranded into quad, 5 quads in a bundle				
Identification of pair in bundles	First pair	Second pair			
	Quad	Wire a	Wire b	Wire a	Wire b
	1	red	white	grey	violet
	2	green	white	grey	violet
	3	blue	white	grey	violet
	4	brown	white	grey	violet
5	orange	white	grey	violet	
spare quad	black	white	grey	violet	
Number of quads in a base unit	5				
Identification of bundles in a base unit	1 st bundle in a unit: red 2 nd bundle in a unit: green Rest of bundles in a unit: white				
Number of quads in a main unit	25 or 50				
Cable core	Stranded bundles wrapped with a polyester tape				
Bundle arrangement in the cable core	No. of quads	Arrangement			
	Nominal	Real (nominal+spare)	Core	1 st layer	
	1	1	1	-	
	3	3	3	-	
	5	5	5	-	
	10	10	2x5	-	
	15	15	3x5	-	
	20	21	4x5+1	-	
	25	26	5x5+1	-	
	35	36	1x5+1	6x5	
	50	51	3x5+1	7x5	
	75	76	2x25+1x26	-	
	100	102	2x25+2x26	-	
	150	153	1x25	2x25+3x26	
200	204	2x25	2x25+3x26		
250	256	2x25+1x26	2x25+5x26		
300	306	1x51	5x51		
400	408	2x51	6x51		
Water barrier	Double-side laminated aluminum tape				
Filling	Petro-jelly				
Drain wire	Tinned copper wire				
Inner sheath	LDPE, black				
Colour of the inner sheath	Black				
Outer sheath	PVC				
Colour of the outer sheath	Black				

CHARACTERISTICS	
Conductor resistance	ø Cu 0.4 mm: max. 150 Ω/km ø Cu 0.6 mm: max. 67 Ω/km ø Cu 0.8 mm: max. 37 Ω/km
Mutual capacitance	Average: 42 µF/km Bundle: 46 µF/km
Insulation resistance min. 5GΩ/km	
Capacitance unbalance K1	100% of values <200 pF/500 m 98% of values 150 pF/500 m
Capacitance unbalance K9-K12	100% of values <800 pF/500 m 95% of values 500 pF/500 m
Minimum bending radius: 15 x D, D - overall diameter of cable	
Production length: 600 m in case of: cables up to 100 quads and ø Cu 0.4 mm cables up to 50 quads and ø Cu 0.6 mm cables up to 35 quads and ø Cu 0.8 mm 300 m for other constructions	
Application	Designed for telecommunication networks

Cable construction	Nominal thickness of the inner and outer sheath		
	Conductor diameter		
	0.4	0.6	0.8
	mm		
1x4	1.4	1.4	1.4
3x4	1.4	1.4	1.4
5x4	1.4	1.4	1.4
10x4	1.4	1.4	1.4
15x4	1.4	1.4	1.4
20x4	1.4	1.4	1.6
25x4	1.4	1.4	1.6
35x4	1.4	1.6	1.6
50x4	1.4	1.6	1.8
75x4	1.6	1.8	1.8
100x4	1.6	1.8	2.0
150x4	1.8	2.0	2.2
200x4	1.8	2.2	2.2
250x4	2.0	2.2	-
300x4	2.0	2.4	-
400x4	2.2	-	-

TCEKFLEDY

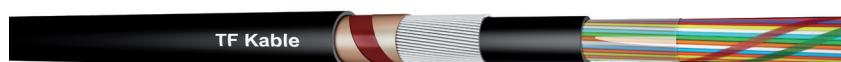

Telecommunication cable						
Standards: TT1-5796						
CONSTRUCTION						
Conductors	Single copper wire					
Diameter of conductor	0.4; 0.6; 0.8 mm					
Insulation	Polyethylene					
Bundle	2 pairs of the insulated wires stranded into quad, 5 quads in a bundle					
Identification of pair in bundles			First pair		Second pair	
	Quad	Wire a	Wire b	Wire a	Wire b	
	1	red	white	grey	violet	
	2	green	white	grey	violet	
	3	blue	white	grey	violet	
	4	brown	white	grey	violet	
	5	orange	white	grey	violet	
spare quad	black	white	grey	violet		
control pair	red	white	-	-		
Number of quads in a base unit	5					
Identification of bundles in a base unit	1 st bundle in a unit: red 2 nd bundle in a unit: green Rest of bundles in a unit: white					
Number of quads in a main unit	25 or 50					
Cable core	Stranded bundles wrapped with a polyester tape					
Bundle arrangement in the cable core	No. of quads	No. of quads in a bundle	No. of bundles in		Spare quad	
			1 st layer	2 nd layer		
	5	5	1	-	-	
	10	5	2	-	-	
	15	5	3	-	-	
	20	5	4	-	1	
	25	5	5	-	1	
	35	5	1	6	1	
	50	5	3	7	1	
75	25	3	-	1		
100	25	4	-	1		
Screen	One-sided laminated aluminium tape					
Drain wire	Tinned copper wire; 0.5 mm					
Inner sheath	LDPE, black					
Armouring	Galvanised steel wires ø 2.5 mm in cables of the outer diameter 35 mm and less ø 3.55 mm in cables of the outer diameter above 35 mm					
Outer sheath	PVC					
Colour of the outer sheath	Black					

CHARACTERISTICS	
Loop resistance	ø Cu 0.4 mm: max. 300 Ω/km ø Cu 0.6 mm: max. 133.2 Ω/km ø Cu 0.8 mm: max. 73.6 Ω/km
Mutual capacitance	Average: 42 µF/km Bundle: 46 µF/km
Insulation resistance min. 5GΩ/km	
Capacitance unbalance K1 (ø Cu 0.4; 0.6 mm)	95% of values <150 pF/500 m max. 250 pF/500 m
Capacitance unbalance K1 (ø Cu 0.8 mm)	95% of values <100 pF/500 m max. 160 pF/500 m
Minimum bending radius: 15 x D, D - overall diameter of cable	
Production length: 600 m in case of: cables up to 100 quads and ø Cu 0.4 mm cables up to 50 quads and ø Cu 0.6 mm cables up to 35 quads and ø Cu 0.8 mm 300 m for other constructions	
Application	Designed for telecommunication networks

Cable construction	Nominal thickness of the inner and outer sheath			Min. thickness of the outer sheath
	Conductor diameter			
	0.4	0.6	0.8	
mm				
1x4	1.4	1.4	1.5	2.1
3x4	1.6	1.6	1.6	2.1
5x4	1.6	1.6	1.8	2.1
10x4	1.6	1.8	1.8	2.1
15x4	1.8	1.8	1.8	2.1
20x4	1.8	1.8	2.0	2.1
25x4	1.8	2.0	2.0	2.1
35x4	1.8	2.0	2.2	2.1
50x4	2.0	2.0	2.2	2.1
75x4	2.0	2.0	2.2	2.1
100x4	2.0	2.2	2.6	2.1

YnTKGMLY-tex



Self-supporting telecommunication cable for mines					
Standards: ZN-BFK-015:1997					
CONSTRUCTION					
Conductors	Stranded copper wire, tinned, 2 nd class				
Insulation	Polyvinyl				
Bundle	Insulated wires stranded into pairs or quads				
Identification of bundles	Pair no.	Wire a	Wire b		
	1	natural	blue		
	2	natural	yellow		
	3	natural	green		
	4	natural	black		
	5	natural	red		
	Quad no.	Wire a	Wire b	Wire c	Wire d
	1	natural	blue	natural	yellow
Cable core	Bundles stranded into layers around the bearing element				
Bearing element	Polypropylene twine				
Outer sheath	Flame retardant polyethylene				
Colour of the outer sheath	Black				
CHARACTERISTICS					
Flame retardant acc. to PN-EN 60332-1-2					
Lowest installation temperature is 0°C. Maximum +50°C					
Minimum working temperature is -30°C. Maximum +70°C					
Minimum bending radius: 7.5 x D, D - overall diameter of cable					
Resistance at 20°C is max. 36.7 Ω/km					
Resistance of insulation 20°C is min. 10MΩ/km					
Mutual capacitance is 75 µF/km					
Minimal breaking force: 90 dN for 1x4x0.5 mm ² cable 220 dN for 5x2x0.5 mm ² cable					
Maximum cable sag: 210 m for 1x4x0.5 mm ² cable 300 m for 5x2x0.5 mm ² cable					
Application	Designed for telecommunication networks in mines both on surface and underground				

Number and cross-section of conductors	Class 2 conductor construction (diameter of fine wires)	Nominal thickness of insulation	Nominal thickness of outer sheath	Approx. cable diameter	Approx. cable weight
n x mm ²	mm		mm		kg/km
1x4x0.5	7x0.3	0.7	1.2	8.0	85
5x2x0.5	7x0.3	0.7	1.2	16.2	217

YnTKGX



Telecommunication cables for mines																
CONSTRUCTION																
Conductors	Copper wire, 0.8 mm in diameter															
Insulation	Polyethylene															
Identification of wires	<table border="1"> <thead> <tr> <th>Pair</th> <th>Wire a</th> <th>Wire b</th> </tr> </thead> <tbody> <tr> <td>counter</td> <td>red</td> <td>natural</td> </tr> <tr> <td>directional</td> <td>blue</td> <td>natural</td> </tr> <tr> <td>odd</td> <td>green</td> <td>natural</td> </tr> <tr> <td>even</td> <td>yellow</td> <td>natural</td> </tr> </tbody> </table>	Pair	Wire a	Wire b	counter	red	natural	directional	blue	natural	odd	green	natural	even	yellow	natural
Pair	Wire a	Wire b														
counter	red	natural														
directional	blue	natural														
odd	green	natural														
even	yellow	natural														
Core filling	Petro-jelly															
Water barrier	Laminated Al foil															
Outer sheath	Flame-retardant polyvinyl															
Colour of the outer sheath	Black															
CHARACTERISTICS																
Lowest installation temperature is -15°C. Maximum +60°C																
Minimum working temperature is -5°C. Maximum +50°C																
Loop resistance: max. 73.6 Ω/km																
Resistance of insulation: min. 5000 MΩ/km																
Mutual capacitance is 60 µF/km																
Minimum bending radius: 15 x D, D - overall diameter of cable																
Application	Designed for telecommunication networks, signalization and machinery in mines															

Cable construction	Number of pairs			Outer sheath thickness	Outer diameter
	1 st layer	2 nd layer	3 rd layer		
				mm	
2x2	2	-	-	1.4	7.7
5x2	5	-	-	1.8	11.0
16x2	5	11	-	1.8	16.4
33x2	5	11	17	1.4	20.4

4GTL3Gekwn-G 300/500

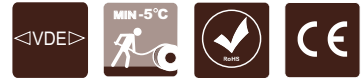
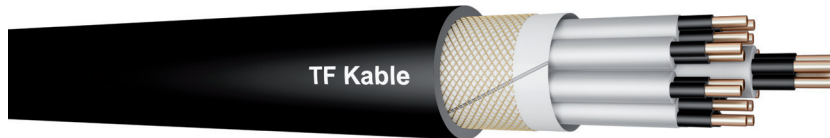

Screened telecommunication cable for mines																					
Standards: ZN-KFK-022:2000; DIN VDE 0250 – 812																					
CONSTRUCTION																					
Conductors	Copper wire of a cross-section of 1; 1.5; and 2.5 mm ² , class 5 acc. to VDE 0295																				
Insulation	EPR-based thermoplastic elastomer: Tensile strength: min. 12.5 MPa Elongation at break: min. 300% Hardness: 70 Shore A																				
Screen	Braid, tinned copper wires. Cover min. 65%																				
Identification of wires	<table border="0"> <tr> <td>1 white – blue</td> <td>11 grey – red</td> </tr> <tr> <td>2 white – red</td> <td>12 grey – blue</td> </tr> <tr> <td>3 white – green</td> <td>13 grey – green</td> </tr> <tr> <td>4 white – brown</td> <td>14 grey – brown</td> </tr> <tr> <td>5 white – black</td> <td>15 grey – black</td> </tr> <tr> <td>6 yellow – red</td> <td>16 orange – red</td> </tr> <tr> <td>7 yellow – blue</td> <td>17 orange – blue</td> </tr> <tr> <td>8 yellow – green</td> <td>18 orange – green</td> </tr> <tr> <td>9 yellow – brown</td> <td>19 orange – brown</td> </tr> <tr> <td>10 yellow – black</td> <td>20 orange – black</td> </tr> </table>	1 white – blue	11 grey – red	2 white – red	12 grey – blue	3 white – green	13 grey – green	4 white – brown	14 grey – brown	5 white – black	15 grey – black	6 yellow – red	16 orange – red	7 yellow – blue	17 orange – blue	8 yellow – green	18 orange – green	9 yellow – brown	19 orange – brown	10 yellow – black	20 orange – black
1 white – blue	11 grey – red																				
2 white – red	12 grey – blue																				
3 white – green	13 grey – green																				
4 white – brown	14 grey – brown																				
5 white – black	15 grey – black																				
6 yellow – red	16 orange – red																				
7 yellow – blue	17 orange – blue																				
8 yellow – green	18 orange – green																				
9 yellow – brown	19 orange – brown																				
10 yellow – black	20 orange – black																				
Inner sheath	Thermoplastic polyolefins (equivalent to polychloroprene CR) Tensile strength: min. 5.0 MPa Elongation at break: min. 250%																				
Inner sheath colour	Black																				
Outer sheath	Thermoplastic polyolefins (equivalent to polychloroprene CR) Tensile strength: min. 9.0 MPa Tear strength: min. 300 N/cm ² Elongation at break: min. 300% UV resistant Reduced flammability (oxygen index: min. 29) Oil and petrol resistant																				
Outer sheath colour	Black																				
CHARACTERISTICS																					
Weather resistance: unrestricted use outdoors and indoors, resistance to ozone and moisture																					
Lowest installation temperature is -5°C. Maximum +60°C																					
Minimum working temperature is -30°C. Maximum +70°C																					
Minimum bending radius: 6 x D, D - overall diameter of cable																					
Flame retardant: IEC 60332-1-2																					
Max. permissible tensile stress with cable grip for Cu-conductor: 50 N/mm²																					
Application	For communication, signal, and control purposes in mining machines working in strip mines or sand pits																				

Technical data

Approx. outer diameter	
2x2x1	13.6 mm
5x2x1	17.0 mm
10x2x1	20.0 mm
20x2x1	27.1 mm

Insulation resistance	min. 200 M Ω ·km
Mutual capacitance (800 Hz)	max. 65 μ F/km
Capacitance asymmetry (c) between adjacent pairs (k)	max. 1.5L pF; L - cable length (m)
Attenuation (800 Hz)	max. 1dB/km
Rated voltage (U₀/U)	300/300 V
Max. operating voltage	500 V (AC, test voltage 1.5 kV, 5 min.)

* Cables cannot be endangered with excessive axial forces during operation.

Static tensile stress of each core during installation and operation cannot exceed the 15 N/mm².

In the machines that occasionally rotates in both directions up to 360° during normal work, the distance between fixed clamps of the cable should be greater at least 50-fold than the outer diameter of the cable. In the machines regularly rotates in both directions up to 360° during normal work, the distance between fixed clamps of the cable should be greater at least 100-fold than the outer diameter of the cable.

YTKGXFoy, YTKGXFty, YTKGXFtly



Screened telecommunication cables for mines			
Standards: ZN-86/MH-80iMP-13-K12098			
CONSTRUCTION			
Conductors	Copper wire, 0.8 mm in diameter		
Insulation	Polyethylene		
Identification of wires	Pair	Wire a	Wire b
	counter	red	natural
	directional	blue	natural
	odd	green	natural
	even	yellow	natural
Inner sheath	Polyvinyl		
Colour of the inner sheath	Black		
Armouring	Foy - steel wires and steel tape Fty - steel tape Ftl - lacquered steel tape		
Outer sheath	Flame-retardant polyvinyl		
Colour of the outer sheath	Black		
CHARACTERISTICS			
Lowest installation temperature is -15°C. Maximum +60°C			
Minimum working temperature is -5°C. Maximum +50°C			
Loop resistance: max. 73.6 Ω/km			
Resistance of insulation: min. 5000 MΩ/km			
Mutual capacitance is 60 µF/km			
Minimum bending radius: 15 x D, D - overall diameter of cable			
Application	Designed -communication networks, signalization and machinery in mines		

Number of pairs in a cable	Number of pairs in the 1 st layer	Number of pairs in the 2 nd layer	Number of pairs in the 3 rd layer	Number of pairs in the 4 th layer
5	5	-	-	-
10	2	8	-	-
16	5	11	-	-
24	2	8	14	-
33	5	11	17	-
56	5	11	17	23
60	6	12	18	23

Cable construction	Inner sheath thickness	Outer sheath thickness	Diameter of steel wires	Steel wire thickness	Outer diameter
mm					
5x2	1.4+/-0.1	1.5+/-0.2	1.4	0.3	14.1
10x2	1.4+/-0.1	1.5+/-0.2	1.4	0.3	17.1
16x2	1.4+/-0.1	1.6+/-0.2	1.8	0.3	19.5
24x2	1.4+/-0.1	1.6+/-0.2	1.8	0.3	21.8
33x2	1.6+/-0.1	1.7+/-0.2	1.8	0.3	24.4
56x2	1.6+/-0.1	1.8+/-0.2	1.8	0.5	30.1
60x2	1.6+/-0.1	1.9+/-0.2	1.8	0.5	32.2

YOTKGtsDFoyn 2-144 fibres

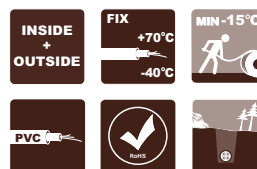

Unfilled, armoured, reinforced for mines					
Standards: TT1-1764/2/0					
CONSTRUCTION					
Element	Type	Material	Dimensions		
Fibres	ITU-T G.652D or according to the attached specifications				
Identification of fibres	Comply to IEC 60304: red; green, blue, white, violet, orange, grey, yellow, brown, pink, black, turquoise				
Identification of tubes/elements	First tube - red, second tube - blue, other tube - natural, filler (when needed) - black				
Central strength member	Straight rod, with a plastic over sheathing when needed	Fibre reinforced plastic	Ø 2.5 mm		
Filling of the tube	Gel	Thixotropic gel	-		
Interstitial water barrier	Dry	Swelling tape	Thickness: 0.20 mm (approx.)		
Reinforcement	Dielectric	Aramid yarns			
Inner sheath	Black	PVC	Thickness:	minimum	0.8 mm
				nominal	1.0 mm
Armouring	Round steel wire	Galvanised steel wires	Ø 1.54 mm		
Outer sheath	Blue	PVC-FR	Thickness:	minimum spot	1.3 mm
				nominal	1.5 mm
Attenuation @1310	≤ 0.4 dB/km*				
Attenuation @1550	≤ 0.25 dB/km*				
* Maximum attenuation for SMF in cable - other parameters of the fibre according to the attached specification					
CHARACTERISTICS					
Lowest installation temperature is -15°C. Maximum +60°C					
Minimum working temperature is -40°C. Maximum +70°C					
Dielectric cable cores					
Resistant to electromagnetic interferences					
Due to the dielectric strength member, aramid reinforcement (option) and armouring made of round steel wires cables are resistant to longitudinal and transverse stress					
Resistant to longitudinal water penetration					
Water penetration - IEC 60794-1-2-F5B (sample 1m, water head 1m, 24 hours)					
Application	Cables are designated for laying on the ground or underground in mines and for mounting horizontally or vertically in pit shafts				

No. of fibres in the cable	Outer diameter of a tube	No. of elements in the cable (tubes/fillers)	Cable dimensions		Max. tensile load		Min. bending radius	
			Outer diameter	Cable weight	Dynamic (during installation)	Static (during operation)	Dynamic (during installation)	Static (during operation)
	mm		mm	kg/km	N		mm	
4-72	2.4	6	17.9+/-0.2	620	8000	3000	360	540
28-96	2.4	8	19.0+/-0.2	740	10000	4000	380	570
36-144	2.4	12	21.9+/-0.2	1000	12000	5000	450	680

YOTKGtsFoyrn 2-144 fibres

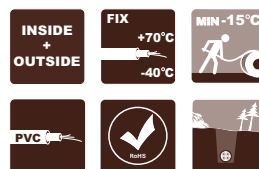

Unfilled, armoured, reinforced for mines					
Standards: TT1-1764/2/0					
CONSTRUCTION					
Element	Type	Material	Dimensions		
Fibres	ITU-T G.652D or according to the attached specifications				
Identification of fibres	Comply to IEC 60304: red; green, blue, white, violet, orange, grey, yellow, brown, pink, black, turquoise				
Identification of tubes/elements	First tube - red, second tube - blue, other tube - natural, filler (when needed) - black				
Central strength member	Straight rod, with a plastic over sheathing when needed	Fibre reinforced plastic	Ø 2.5 mm		
Filling of the tube	Gel	Thixotropic gel	-		
Interstitial water barrier	Dry	Swelling tape	Thickness: 0.20 mm (approx.)		
Inner sheath	Black	PVC	Thickness:	minimum	1.2 mm
				nominal	1.4 mm
Armouring	Round steel wire	Galvanised steel wires	Ø 1.54 mm		
Outer sheath	Blue	PVC-FR	Thickness:	minimum spot	1.3 mm
				nominal	1.5 mm
Attenuation @1310	≤ 0.4 dB/km*				
Attenuation @1550	≤ 0.25 dB/km*				
* Maximum attenuation for SMF in cable - other parameters of the fibre according to the attached specification					
CHARACTERISTICS					
Lowest installation temperature is -15°C. Maximum +60°C					
Minimum working temperature is -40°C. Maximum +70°C					
Dielectric cable cores					
Resistant to electromagnetic interferences					
Due to the dielectric strength member, aramid reinforcement (option) and armouring made of round steel wires cables are resistant to longitudinal and transverse stress					
Resistant to longitudinal water penetration					
Water penetration - IEC 60794-1-2-F5B (sample 1m, water head 1m, 24 hours)					
Application	Cables are designated for laying on the ground or underground in mines and for mounting horizontally or vertically in pit shafts				

No. of fibres in the cable	Outer diameter of a tube	No. of elements in the cable (tubes./ fillers)	Cable dimensions		Max. tensile load		Min. bending radius	
			Outer diameter	Cable weight	Dynamic (during installation)	Static (during operation)	Dynamic (during installation)	Static (during operation)
	mm		mm	kg/km	N		mm	
4-72	2.4	6	18.2+/-0.2	630	6000	3000	370	550
28-96	2.4	8	19.2+/-0.2	760	8000	4000	385	580
36-144	2.4	12	22.1+/-0.2	1020	10000	5000	460	690

YOTKGtsDFtlyn 4 - 72 fibres

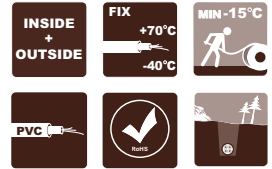

Unfilled, armoured, reinforced for mines			
Standards: TT1-1837/2/0			
CONSTRUCTION			
Element	Type	Material	Dimensions
Fibres	ITU-T G.652D or according to the attached specification		
Identification of fibres	Comply to IEC 60304: red; green, blue, white, violet, orange, grey, yellow, brown, pink, black, turquoise		
Secondary coating	Loose tube	PBT	Ø 2.5 mm
Secondary coating filling	Gel	Thixotropic gel	
Identification of tubes/elements	First tube - red, second tube - blue, other tubes - natural; filler (when needed) - black		
Central strength member	Straight rod, with a plastic sheath when needed	Fibre reinforced plastic	Ø 2.5 mm
Interstitial water barrier	Swelling tape		Thickness: 0.25 mm (approx.)
Reinforcement	Dielectric	Aramid yarns	
Inner sheath	Black	PVC	Nominal thickness: 1.0 mm
Armouring	Tape	Lacquered steel tape	Thickness: 0.3 mm
Outer sheath	Blue	PVC-self-extinguishing	Nominal thickness: 1.5 mm
Attenuation @1310 nm	≤ 0.4 dB/km*		
Attenuation @1550 nm	≤ 0.25 dB/km*		
* Maximum attenuation for SMF in cable - other parameters of the fibre according to the attached specification			
CHARACTERISTICS			
Lowest installation temperature is -15°C. Maximum +60°C			
Minimum working temperature is -40°C. Maximum +75°C			
Dielectric cable cores			
Resistant to electromagnetic interferences			
Due to the dielectric strength member, aramid reinforcement (option) and armouring made of steel tape cables are resistant to longitudinal and transverse stress			
Resistant to longitudinal water penetration			
Application	Cables are designated for laying on the ground or underground in mines and for mounting horizontally or vertically in pit shafts		

No. of fibres in the cable	Outer diameter of a tube	Cable dimensions		Max. tensile load		Min. bending radius	
		Outer diameter	Cable weight	Dynamic (during installation)	Static (during operation)	Dynamic (during installation)	Static (during operation)
		mm	kg/km	N		mm	
4 - 72	2.4	6	15.1+/-2	4000	2000	300	225

ZW-(QG)GNOTKSdD 4-8 J

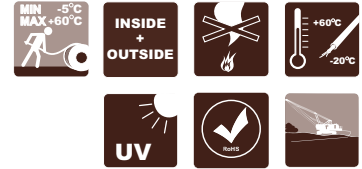
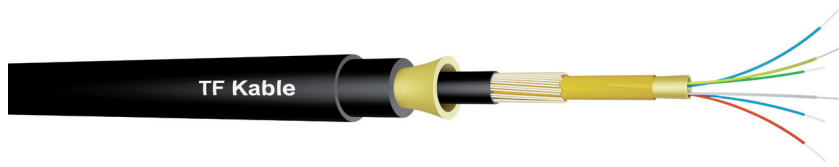

Dielectric, reinforced cable for mines			
Standards: TT1-2078/3/0			
CONSTRUCTION			
Element	Type	Material	Dimensions
Optical fibres	ITU-T G.652D or acc. to the attached optical fibre specification		
Identification of fibres	Colours acc. to IEC 60304: red, green, blue, white, violet, orange, grey, yellow		
Secondary coating	Tight buffer - inner layer material - outer layer material	Acryl Polyamide	Ø 0.9 mm
Identification of the secondary coating	Natural colour or acc. to IEC 60304		
Optical module reinforcement	Dielectric yarn	Aramid	-
Optical module sheath	ITU-T G652D fibres - yellow ITU-T G651 (G62,5) fibres - green ITU-T G651 (G50) fibres - orange ITU-T G655 fibres - brown	LSOH	Thickness: 0.6 mm
Dielectric armouring	Dielectric rods	FRP	Ø 1.0 mm
Inner sheath	-	Thermoplastic rubber	Thickness: 1.0 mm
Cable reinforcement	Dielectric yarn	Aramid	-
Outer sheath	Inner layer	Thermoplastic rubber	Thickness min. 2.5 mm nominal 3.0 mm
	Outer layer	Polyurethane	Thickness min. 1.2 mm nominal 1.5 mm
Attenuation @1310	≤ 0.5 dB/km*		
Attenuation @1550	≤ 0.35 dB/km*		
* Maximum attenuation of SM fibres G/652D, other parameters acc. to the attached optical fibre specification			
CHARACTERISTICS			
Lowest installation temperature is -5°C. Maximum +60°C			
Minimum working temperature is -20°C. Maximum +60°C			
Fully dielectric			
Resistant to electromagnetic interferences			
Highly resistant to repeated bending and stretching			
Sheaths made of the material of a high oxygen index			
Application	Suitable for digital and analogue transmission in full optical bandwidth. Designed for laying on the ground or underground. It can be mounted horizontally or vertically and on the moving parts of machines, where high resistance to repeated winding, unwinding and bending is required		

No. of fibres in the cable	Outer diameter of a tube	No. of elements in the cable (tubes./fillers)	Cable dimensions		Max. tensile load		Min. bending radius (static and dynamic)
			Outer diameter	Cable weight	Dynamic (during installation)	Static (during operation)	
	mm		mm	kg/km	N		mm
4; 6	0.9	4; 6	≤18.0	340	6000	4000	140
8	0.9	8	≤19.0	365	6000	4000	150

PSKD 2-24 Optical Fibre

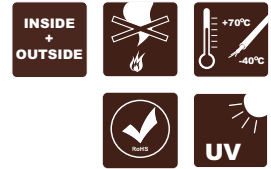

Indoor-outdoor, non-metallic, tactical			
Standards: TT1-1717/2/0			
CONSTRUCTION			
Element	Type	Material	Dimensions
Optical fibres	ITU-T G.652D or according to the attached specifications		
Identification of fibres	Complies with IEC 60304: red, green, blue, white, violet, orange, grey, yellow, brown, pink, black turquoise More than 12 fibres: single or double stripes		
Secondary coating	Tight buffer tube - material (inner layer) - material (outer layer)	Soft acrylic polymer polyamide	Ø 0.9 mm
Tube colour	Natural or acc. to IEC 60304 More than 12 fibres: single or double stripes		
Supporting elements/ reinforcement	Dielectric	Aramid yarns	
Inner sheath	Black	Extruded polymer polyurethane	Thickness: minimum spot - 0.5 mm average - 0.6 mm
Outer sheath	Black	Extruded polymer polyurethane	Thickness: minimum spot - 0.5 mm average - 0.6 mm
Attenuation @1310 mm	≤ 0.5 dB/km*		
Attenuation @1550 mm	≤ 0.35 dB/km*		
* Maximum attenuation for SMF in cable - other parameters of the fibre according to the attached specification			
CHARACTERISTICS			
Lowest installation temperature is -40°C. Maximum +70°C			
Minimum working temperature is -55°C. Maximum +85°C			
Light and durable due to double aramid reinforcement			
Resistant to electromagnetic interferences			
Highly flexible in low temperatures due to double polyurethane sheaths			
Suitable for repeated winding and unwinding			
Highly resistant to chemical agents, abrasion, mechanical vibrations			
Fire resistant due to flame-retardant zero-halogen polyurethane			
Resistant to longitudinal water penetration			
Can be installed in the proximity to electric installation			
Application	Designated for use in heavy environmental conditions, where high resistance to mechanical damage is required. Suitable for military use; in places where geological, archaeological or mining works are being carried, both in the open air and underground. Recommended if frequent winding and unwinding is required		

No. of fibres in the cable	Outer diameter of a tube	Cable dimensions		Max. tensile load		Min. bending radius	
		Outer diameter	Cable weight	Dynamic (during installation)	Static (during operation)	Dynamic (during installation)	Static (during operation)
	mm	mm	kg/km	N		mm	
2	0.9	5.8	24	2500	1250	85	110
4	0.9	5.8	25	2500	1250	85	110
6	0.9	6.3	29	2500	1250	85	110
8	0.9	6.5	32	2500	1250	90	120
12	0.9	7.1	38	2500	1250	100	130
18	0.9	7.9	49	2500	1250	115	155
24	0.9	9.5	66	2500	1250	140	190

Test	Standard	Value	Acceptance criteria
Crush	PN EN 187000:2001 Method 504	3 kN; t = 15 min	$\Delta\alpha \leq 0.5$ dB @1310 nm (SMF) $\Delta\alpha \leq 1.0$ dB @1300 nm (MMF) no damage
Impact	PN EN 187000:2001 Method 505	10 Nm, 100 impacts	$\Delta\alpha \leq 0.5$ dB @1310 nm (SMF) $\Delta\alpha \leq 1.0$ dB @1300 nm (MMF) no damage
Repeat bending	PN EN 187000:2001 Method 507	60N, 2000 cycles, 90°	$\Delta\alpha \leq 0.5$ dB @1310 nm (SMF) $\Delta\alpha \leq 1.0$ dB @1300 nm (MMF) no damage
Torsion	PN EN 187000:2001 Method 508	20 cycles, 360°	$\Delta\alpha \leq 0.5$ dB @1310 nm (SMF) $\Delta\alpha \leq 1.0$ dB @1300 nm (MMF) no damage

YOTKGtsFtlyn 2-72

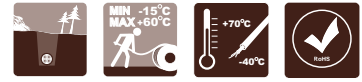

For horizontal installation in mines			
Standards: TT1-1506/2/0			
CONSTRUCTION			
Element	Type	Material	Dimensions
Optical fibres	ITU-T G.652D or acc. to the attached optical fibre specification		
Identification of fibres	Acc. to IEC 60304: red, green, blue, white, violet, orange, grey, yellow, brown, pink, black, turquoise		
Identification of the secondary coating	1 st tube - red, 2 nd tube - blue, other - natural Fillers (when used) - black		
Material of the secondary coating	Thermoplastic material	PBT	Ø approx. 2.4 mm
Central strength element	Rod	FRP	Ø 2.5 mm
Filling of the secondary coating	Jelly	Tixotropic jelly	
Cable core sealing	Dry	Swelling tape	
Inner sheath	Black	PVC	Nominal thickness: 1.4 mm
Armouring	Tape	Lacquered steel	0.30 x 20 mm
Outer sheath	Blue	PVC self-extinguishing	Average thickness: 1.70 mm
Attenuation @1310 nm	≤ 0.5 dB/km*		
Attenuation @1550 nm	≤ 0.35 dB/km*		
* Maximum attenuation of SM fibres G/652D, other parameters acc. to the attached optical fibre specification			
CHARACTERISTICS			
Fully dielectric			
Lowest installation temperature is -15°C. Maximum +60°C			
Minimum working temperature is -40°C. Maximum +70°C			
Resistant to electromagnetic interferences			
Extremely resistant to longitudinal and transverse tension due to central strength element, aramid yarn reinforcement and steel tape armouring			
Secured against longitudinal water penetration			
Outer sheath made of UV-resistant, self-extinguishing PVC			
Application	Designed for connection between optical devices. Suitable for laying on and below the ground; can be mounted horizontally		

No. of fibres in the cable	Outer diameter of a tube	No. of the construction elements in the cable (tubes/fillers)	Cable dimensions		Max. tensile load		Min. bending radius (static and dynamic)	
			Outer diameter	Cable weight	Dynamic (during installation)	Static (during operation)		
mm			mm	kg/km	N		mm	mm
2 - 72	2.4	6	15.1	310	2500	1250	230	300



We bring the
safe energy

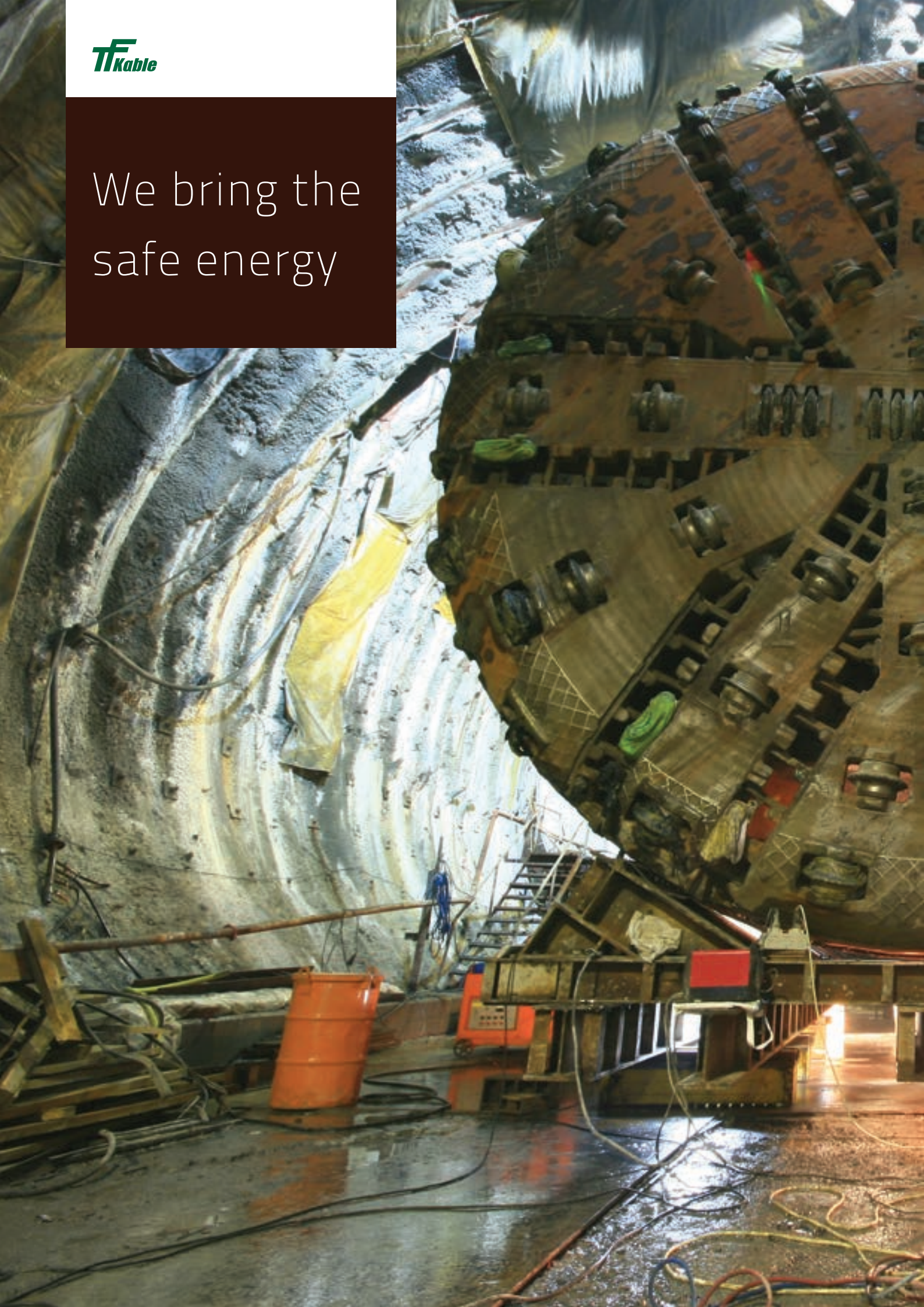



TUNNELING CABLES

(N)3GHSSYCY

186

(N)3GHSSYCY



Medium voltage power cables	
Standards: DIN VDE 0250 p. 605	
CONSTRUCTION	
Conductors	Annealed flexible stranded bare copper class 5 to IEC 60228
Separator	If needed a suitable semi-conductive tape between the conductor and insulation
Power cores	Annealed bare copper conductor covered with semi-conducting layer and rubber insulated with EPR, semi-con. layer over insulation. On outer layer the wrap of Cu wires - covering min. 80%. Under the wires semi-conducting tape
Assembly	Three copper screened power cores laid up with interstitial insulated pilot cores
Filling and internal covering	Filling rubber + PVC
Concentric screen	The braid from 0.4 mm from Cu of wires +the wrap of synthetic tape
Internal jacket	PVC type YM5 acc. to DIN VDE 0207-5
Armour	The braid from galvanized steel wires diameter 0.45 mm. The wrap of polyester tape
Outer jacket	PVC YM5 acc. to DIN VDE 0207-5.
Colour of outer jacket	Red
CHARACTERISTICS	
Flame retardant	
Temperature range -5°C to +80°C. For fixed installation lowest temperature is -40°C	
Application	As feeder cable for power supply of shiftable MV equipment, explosion proof transformers, for underground applications Other industrial applications
Standard length cable packing	500 m on drums. Other forms of packing and delivery are available on request

Number of cores Cross-section	Insulation thickness	Filling rubber and PVC layer thickness	Outer jacket thickness	Approximate overall diameter	Approximate weight	Current-carrying capacity at 30°C
mm ²	mm	mm	mm	mm	kg/km	A
6/10 kV						
3x35+3x16/3E+3x2.5+UL	3.4	1.2+1.4	3.0	57.9	5129	161
3x50+3x25/3E+3x2.5+UL	3.4	1.2+1.4	3.0	62.2	5975	202
3x70+3x35/3E+2x2.5+UL	3.4	1.2+1.4	3.0	66.1	7248	251
3x95+3x50/3E+3x2.5+UL	3.4	1.2+1.4	3.0	71.5	8732	301
3x120+3x70/3E+3x2.5+UL	3.4	1.2+1.4	3.0	73.8	9811	351
12/20 kV						
3x35+3x16/3E+3x2.5+UL	5.5	1.2+1.4	3.0	67.0	6555	161
3x50+3x25/3E+3x2.5+UL	5.5	1.2+1.4	3.0	71.3	7644	202
3x70+3x35/3E+3x2.5+UL	5.5	1.2+1.4	3.0	75.2	8945	251
3x95+3x50/3E+3x2.5+UL	5.5	1.2+1.4	3.0	80.6	10483	301
3x120+3x70/3E+3x2.5+UL	5.5	1.2+1.4	3.0	82.8	11548	351
3x150+3x70/3E+3x2.5+UL	5.5	1.2+1.4	3.0	85.9	12940	428

CABLE DRUMS

Sample data of wooden cable drums

Sample data regarding wooden cable drums														
Type		060	070	80	08A	090	100	10A	120	140	150	160	180	200
Ø D	mm	600	700	800	800	900	1000	1000	1200	1400	1500	1600	1800	2000
Ø D1	mm	300	350	400	400	450	500	500	600	700	800	800	1000	1200
B	mm	510	510	510	670	690	700	790	845	865	870	1055	1070	1090
L	mm	400	400	400	560	560	560	650	710	710	710	900	900	900
Weight	kg	20	26	33	36	54	71	73	104	153	180	233	311	442

Sample data regarding wooden cable drums													
Type		20A	20B	210	220	22A	22B	22M	240	24A	24B	24E	250
Ø D	mm	2000	2000	2100	2200	2200	2200	2200	2400	2400	2400	2400	2500
Ø D1	mm	1000	1250	1100	1200	1400	1600	1400	1400	1200	1000	1200	1600
B	mm	1090	1310	1540	1335	1485	1460	1335	1440	1440	1755	1660	1505
L	mm	900	1100	1300	1100	1250	1250	1100	1210	1210	1500	1450	1250
Weight	kg	409	465	554	616	681	735	663	754	706	762	730	951

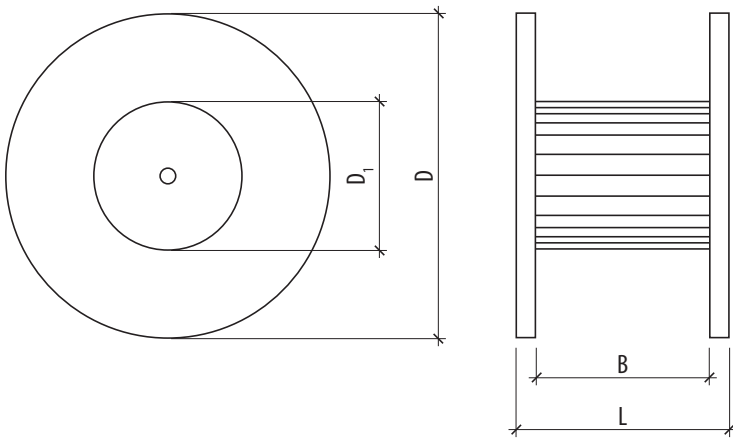

Note: Figures used are indicative and may vary due to manufacturing tolerances, so should only be used as guidance.

DESCRIPTION OF PICTOGRAMS USED IN CATALOGUE



Minimum and maximum exploitation temperature



Minimum outside temperature allowed to operate



Minimum installation temperature



Minimum and maximum installation temperature



Maximum conductor operating temperature



Universal cable, for outdoor and indoor installation



Cable with PVC sheath



Direct buried cable, for installation in terrain with low risk of mechanical damage



Trailing cable



Underground cable



Cylindrical winding



Non-flammable sheath



Fire resistant



Oil resistant



UV resistant



Cable approved by VDE



Cable complies with requirements of RoHS directive



Cable conforms with the essential requirements of the applicable EC directives



Positive results for vertical flame spread test acc. to IEC 60331-1-2

NOTES



All the information contained in this document - including tables, graphics and diagrams - is given in good faith and believed to be correct at the time of publication. The information does not constitute a warranty nor representation for which TELE-FONIKA Kable assumes legal responsibility. TELE-FONIKA Kable reserves rights to introduce changes to the document at any time.

All Rights Reserved – TELE-FONIKA Kable S.A.

Edition II



TELE-FONIKA Kable S.A.

Wielicka 114, 30-663 Krakow, Poland

T: (+48) 12 372 73 19, (+48) 12 372 73 06, (+48) 12 372 73 05

mining@tfkable.com

www.tfkable.com

