

The top brand of trade. The headstream of innovational technologies.



**XIANGFAN GUOWANG
COMPOSITE INSULATORS
CO.,LTD.**

CONTENTS

The top brand of trade.

The headstream of innovational technologies.

The earliest manufacturer which develops and produces the composite insulator in China. One of the earliest manufacturers which develops and produces the composite insulator in the world.

01 SERIES OF PRODUCT

03 ABOUT US

05 TESTING EQUIPMENTS

07 CONFIGURATION

08 MANAGEMENT SYSTEM CERTIFICATION

11 DESIGN FEATURES

12 CONFIGURATION OF END-FITTINGS

13 PRODUCT CHARACTERISTICS

18 TEST REPORT

21 COMPANY HISTORY

23 GLOBAL MARKET

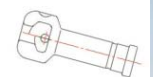

Series of Product

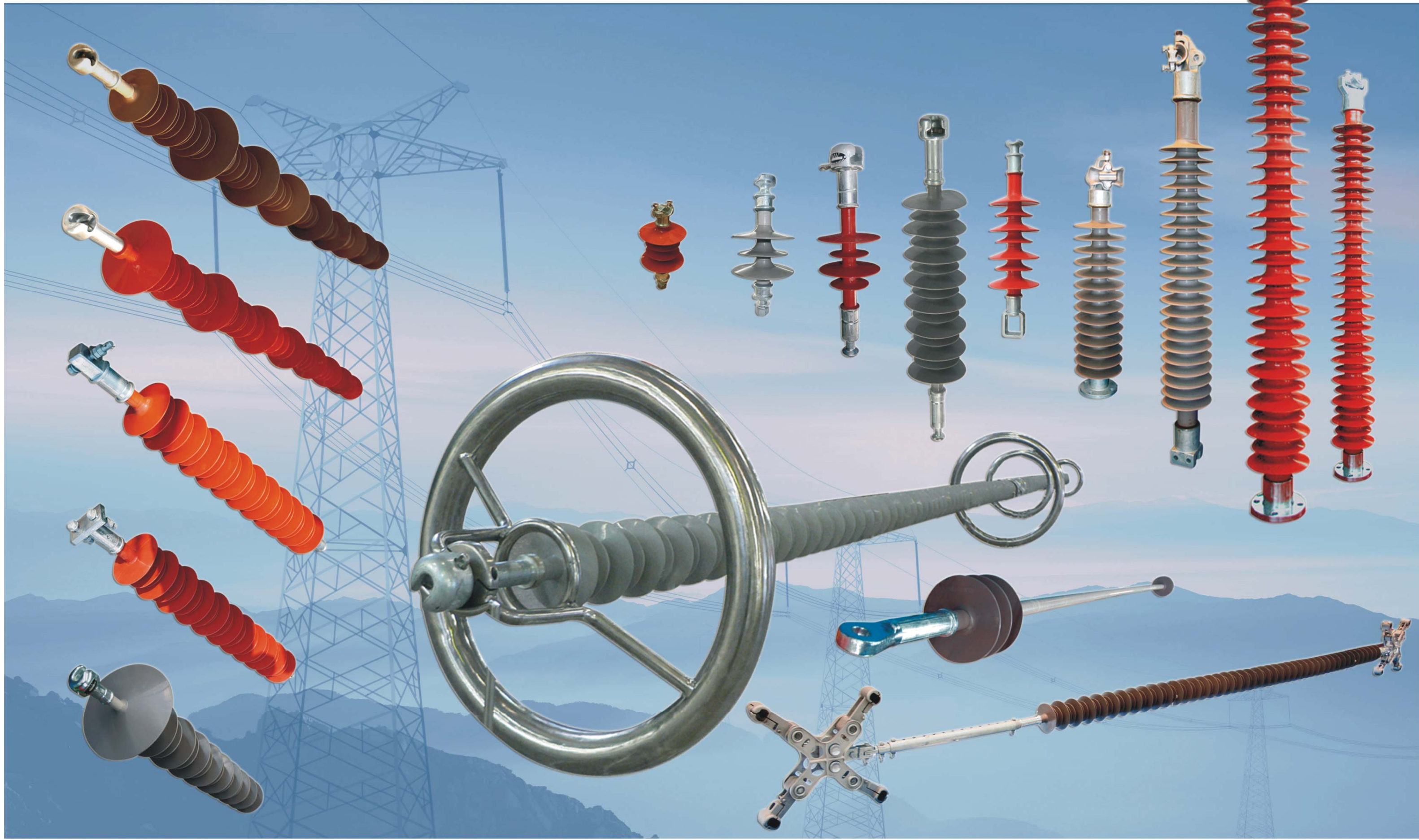



About Us

Xiangfan Guowang Composite Insulators Co.,Ltd. (Xiangfan Guowang), previously the branch of Xiangfan Electric Power Equipments Factory which was established in 1987, is the earliest in China which develops and produces composite insulator.

Xiangfan Guowang Company is the largest composite insulator manufacturer in Asia-pacific with an annually production capacity of 1,000,000 pcs of standard composite insulators. It's the key high-tech enterprise of "National Torch Plan", high-tech enterprise and reserve listed enterprise of Hubei province.

The company has two kinds of production technology: injection molding process and extruding process, has the most advanced testing equipments and methods in the same industry. Our products cover 31 provinces in China and export to more than 28 countries like India, Italy, Britain, Iran, Vietnam, Korea etc.

Company missions of "Science and technology bears a powerful country, excellence earns the world's attention" has been performed. The company has developed suspension composite insulator, pin type composite insulator, line post composite insulator, Interphase composite spacer. The specialized composite insulator of preventing from bird hazard, anti-windage yaw, electrified railway used composite insulator, the series products of anti-pollution coating materials.

Each performance index of our products achieved the national standard and IEC standard, and passed the type test of authoritative third party (State Grid Electric Power Research Institute and China Electric Power Research Institute

of China). TONLY™ composite insulator has passed the aging test under operating voltage simulating weather conditions in KEMA laboratory of Netherlands, the type test in Powertech laboratory of Canada and CESI laboratory of Italy.

More than 10 million products from our company have been put into operation under different geographic and climatic conditions in the global, the longest operation time is more than 20 years. There's none accident of breakdown of inner-insulator or brittle fracture of FRP rod happened.

Since 1996, TONLY™ composite insulator has been successively titled as the famous brand of Hubei province, national independent innovation product and national-class key new product. 1000kV Extra High Voltage AC composite insulator was listed as "National Torch Plan".

The company is the only one which passed ISO9001, ISO14001 and OHSAS 18001 in the same industry. In 2010, it was selected as Top-Ten insulator brand and the most competitive insulator supplier by China bidding website.

The company has strong ability in the area of research, design and manufacture. The R&D center was assessed as provincial enterprise technology center, we have more than 20 items of science and technology achievements and authorized patents.

In 2011, Xiangfan Guowang Composite Insulators Co. Ltd expand production capacity once again, we will build a new injection molding production line and then we will have annually production capacity of 2,000,000 pcs of standard composite insulators.



Testing equipments



The company has sophisticated testing equipments in the same industry. These equipments can complete various tests including raw material test, semi-finished products test and finished products test to ensure products good quality.

Main testing equipments: 1000KV power frequency test equipment, 1200KV steep front impulse test equipment, 400KV DC generator, 800KN tensile load machine, tracking and erosion test device, oil puncture test device, rubber tensile machine and arrester parameter test machine etc.

CONFIGURATION





THE INTERNATIONAL CERTIFICATION NETWORK

CERTIFICATE

IQNet and CQM
hereby certify that the organization

Xiangfan Guowang Composite Insulators Co.,Ltd.

Domicile: No.10, Dengman Road, New & Hi-Tech Products Development Zone, Xiangfan City, Hubei, P.R.China
Certification Add.: No.10, Dengman Road, Industry Park, High New Zone, Xiangfan City, Hubei, P.R.China

Postcode.:441057
is in conformity with

ISO 14001:2004 Standard

This certificate is valid to the following product(s)/service:
The design, development, production and service of composite insulators and relevant environment management activities

Issued on: 2008-08-28

Validity date: 2011-08-27

Registration Number: CN-00208E20868R0M



René Wasmer
President of IQNet

Zhang Wei
CEO of CQM



IQNet Partners*:
AENOR Spain AFAQ AFNOR France AIB-Vincotte International Belgium ANCE Mexico APCER Portugal CISQ Italy CQC China
CQM China CQS Czech Republic Cro Cert Croatia DQS Germany DS Denmark ELOT Greece FCAV Brazil
FONDONORMA Venezuela HKQAA Hong Kong China ICONTEC Colombia IMNC Mexico Inspecta Certification Finland
IRAM Argentina JQA Japan KFQ Korea MSZT Hungary Nemko AS Norway NSAI Ireland PCBC Poland
Quality Austria Austria RR Russia SAI Global Australia SII Israel SIQ Slovenia SIRIM QAS International Malaysia
SQS Switzerland SRAC Romania TEST St Petersburg Russia YUQS Serbia
IQNet is represented in the USA by: AFAQ, AFNOR, CISQ, DQS, NSAI Inc. and SAI Global

* The list of IQNet partners is valid at the time of issue of this certificate. Updated information is available under www.iqnet-certification.com



THE INTERNATIONAL CERTIFICATION NETWORK

CERTIFICATE

IQNet and CQM
hereby certify that the organization

Xiangfan Guowang Composite Insulators Co.,Ltd.

Domicile: No.10, Dengman Road, New & Hi-Tech Products Development Zone, Xiangfan City, Hubei, P.R.China
Certification Add.: No.10, Dengman Road, Industry Park, High New Zone, Xiangfan City, Hubei, P.R.China

Postcode.:441057
is in conformity with

OHSAS 18001:1999 Standard

This certificate is valid to the following product(s)/service:
The design, development, production and service of composite insulators and relevant OHS management activities

Issued on: 2008-08-28

Validity date: 2011-08-27

Registration Number: CN-00208SI0546R0M



René Wasmer
President of IQNet

Zhang Wei
CEO of CQM



IQNet Partners*:
AENOR Spain AFAQ AFNOR France AIB-Vincotte International Belgium ANCE Mexico APCER Portugal CISQ Italy CQC China
CQM China CQS Czech Republic Cro Cert Croatia DQS Germany DS Denmark ELOT Greece FCAV Brazil
FONDONORMA Venezuela HKQAA Hong Kong China ICONTEC Colombia IMNC Mexico Inspecta Certification Finland
IRAM Argentina JQA Japan KFQ Korea MSZT Hungary Nemko AS Norway NSAI Ireland PCBC Poland
Quality Austria Austria RR Russia SAI Global Australia SII Israel SIQ Slovenia SIRIM QAS International Malaysia
SQS Switzerland SRAC Romania TEST St Petersburg Russia YUQS Serbia
IQNet is represented in the USA by: AFAQ, AFNOR, CISQ, DQS, NSAI Inc. and SAI Global

* The list of IQNet partners is valid at the time of issue of this certificate. Updated information is available under www.iqnet-certification.com

DESIGN FEATURES

The structural design of TONLY™ Composite insulator consists of these basic parts:

CORE - is fiberglass reinforced epoxy resin rod which produced from the highest quality materials. It is the component to bear mechanical load and has minimum tension strength at 1000Mpa.

END FITTINGS - are made of steel with hot-dip galvanized. They are compressed directly to the rod by a special process.

SHEATH & WEATHERSHEDS - are produced with High Temperature Vulcanized silicone rubber compound which exhibit high, long-term hydrophobicity, high aging resistance, high corona resistance and low permeability to moisture.

INTERFACES - between the fiberglass rod, rubber sheath, and rubber sheds are laid on a special adhesive that compound on the basis of silicone rubber and then vulcanized. This firmly bonds the rubber to the rod and bonds the rubber sheds to the rubber sheath so that the joint between sheds and sheath is stronger than the rubber.

For suspension insulator with SML on or above 120kN, the interface between the metal fittings and the sheath is fitted on an additional o-ring seal beside of the special sealant.

CORONA RING - is made of aluminum. The corona ring is necessary at 220kV system and above. For application at 220kV and 230kV, one corona ring should be assembled at the line end of the suspension insulator; For application at 345kV and greater, two corona rings should be assembled at both end of insulators. There are seven types of corona rings for option-1: R250, R305, R350, R370 and option-2: R250-2, R305-2, R370-2.

Option-1:

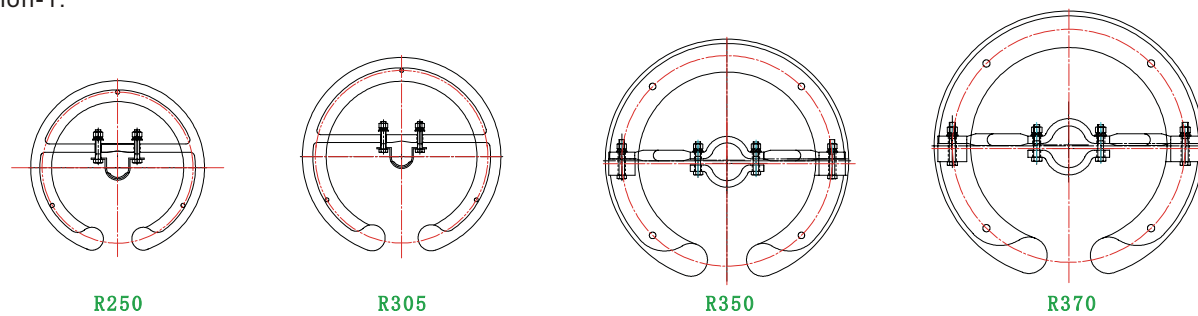

Option-2:

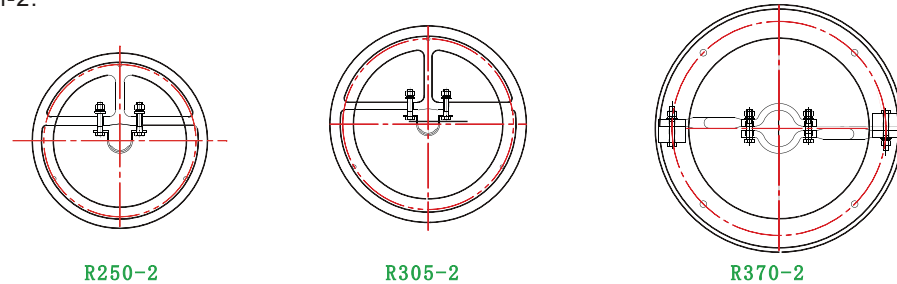

CONFIGURATION OF END-FITTINGS

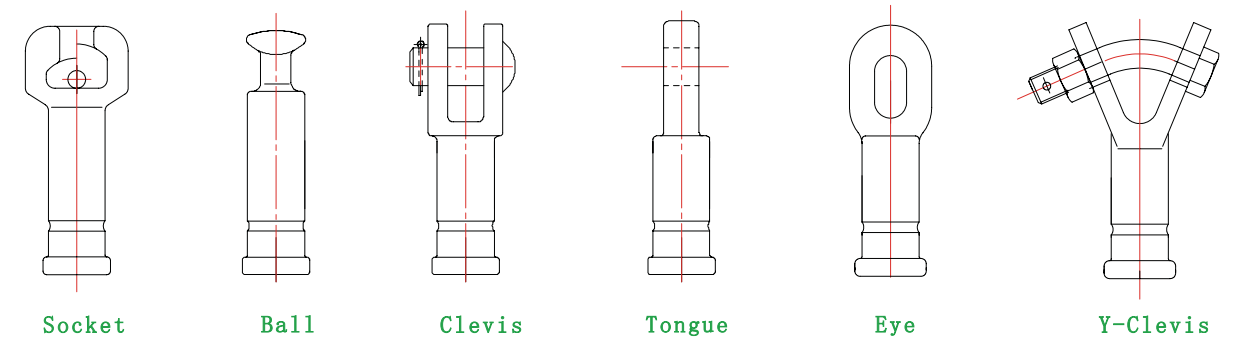

The designation of the above end-fittings are in accordance with IEC61466-1(Composite string insulator units for overhead lines with a nominal voltage greater than 1000V-part1:Standard strength classes and end fittings); The ANSI classes are also available.

CATALOG NUMBER DEFINITION:

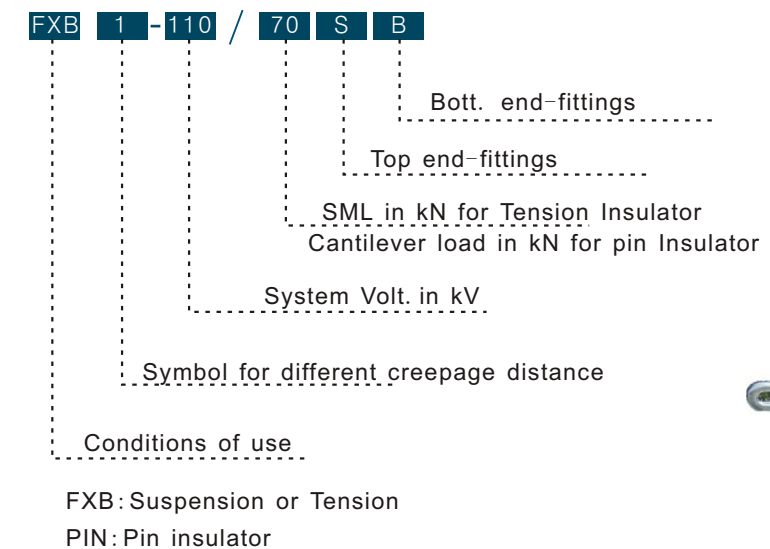

Configuration of end-fittings:
 B: Ball C: Clevis E: Eye
 S: Socket T: Tongue
 Y: Y-Clevis Z: Others

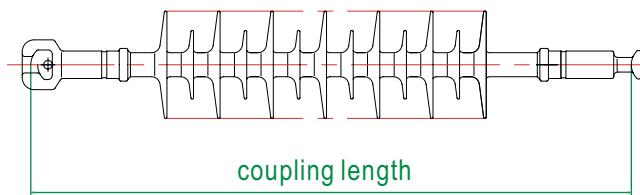

TONLY™ SUSPENSION COMPOSITE INSULATORS

CHARACTERISTICS
SML: 70kN

Catalogue Number	Normal system volt. (KV)	Approx. Dimensions (mm)			Electrical Ratings				Net Weight (kg)
		Coupling length	Min. Creepage distance	Dry arc distance	Power freq. Flashover (KV)		Impulse Flashover (KV)		
					Dry	Wet	Pos.	Neg.	
FXB2-22/70SB	22	380	480	200	90	65	140	145	1.8
FXB3-22/70SB		380	600	200	90	65	140	145	2
FXB4-22/70SB		438	770	258	105	85	160	165	2.3
FXB5-22/70SB		1060	2900	820	340	310	530	550	5.6
FXB2-33/70SB	33/35	580	720	400	160	145	270	280	2.2
FXB3-33/70SB		580	900	400	160	145	270	280	2.5
FXB4-33/70SB		620	1116	440	175	160	290	300	2.7
FXB5-33/70SB		660	1440	480	190	170	340	350	3.2
FXB6-33/70SB		660	1800	480	190	170	340	350	4
FXB1-69/70SB	66/69	800	1160	620	240	220	390	410	2.7
FXB2-69/70SB		895	1450	715	275	250	400	420	3.1
FXB3-69/70SB		895	1813	715	275	250	400	420	3.7
FXB4-69/70SB		920	2248	740	285	260	480	500	4.4
FXB5-69/70SB		1000	2900	820	340	310	530	550	5.3
FXB2-110/70SB	110/115	1180	2540	1000	380	342	625	650	4.5
FXB3-110/70SB		1180	3175	1000	380	342	625	650	5.7
FXB4-110/70SB		1260	3940	1080	410	370	670	690	6.7
FXB5-110/70SB		1580	5800	1400	530	470	850	900	9.8
FXB2-132/70SB	132/138	1280	2900	1100	420	380	680	700	4.9
FXB3-132/70SB		1400	3625	1220	460	410	740	760	5.8
FXB4-132/70SB		1540	4495	1360	510	460	820	870	7.3
FXB5-132/70SB		1580	5800	1400	530	470	850	900	9.8
FXB2-220/70SB	220/230	2100	4900	1920	720	648	1140	1190	7.5
FXB3-220/70SB		2100	6125	1920	720	648	1140	1190	9.5
FXB4-230/70SB		2240	7595	2060	760	680	1220	1250	11.5
FXB5-230/70SB		2340	8575	2160	810	720	1280	1340	13.8
FXB6-230/70SB		2640	9800	2460	910	820	1440	1500	15.5

Note: 1. All tests are in accordance with IEC61109;

2. All units for 220kV system voltage should be assembled one corona ring at the line end.

3. For other fittings, use the suffixes indicated above. Specify the top fitting first. For example: for clevis top and tongue bottom, add the suffix CT instead of the suffix SB. If both end fittings are to be same, just specify one letter.

Example: for clevis at both end, just add C suffix instead of the suffix SB .

TONLY™ SUSPENSION COMPOSITE INSULATORS
CHARACTERISTICS
SML: 120kN

Catalogue Number	Normal system volt. (KV)	Approx. Dimensions (mm)			Electrical Ratings				Net Weight (kg)
		Coupling length	Min. Creepage distance	Dry arc distance	Power freq. Flashover (KV)		Impulse Flashover (KV)		
					Dry	Wet	Pos.	Neg.	
FXB1-69/120SB	66/69	860	1160	620	240	220	390	410	3
FXB2-69/120SB		955	1450	715	275	250	400	420	3.4
FXB3-69/120SB		955	1813	715	275	250	400	420	4
FXB4-69/120SB		980	2248	740	285	260	480	500	4.8
FXB5-69/120SB		1060	2900	820	340	310	530	550	5.6
FXB2-110/120SB	110/115	1240	2540	1000	380	342	625	650	4.8
FXB3-110/120SB		1240	3175	1000	380	342	625	650	6
FXB4-110/120SB		1320	3940	1080	410	370	670	690	7
FXB2-132/120SB	132/138	1340	2900	1100	420	380	680	700	5.2
FXB3-132/120SB		1460	3625	1220	460	410	740	760	6.1
FXB4-132/120SB		1600	4495	1360	510	460	820	870	7.6
FXB5-132/120SB		1640	5800	1400	530	470	850	900	10.2
FXB2-154/120SB	154	1606	3080	1366	515	465	825	875	5.6
FXB4-154/120SB		1606	5184	1366	515	465	825	875	9.2
FXB2-220/120SB	220/230	2160	4900	1920	720	648	1140	1190	7.8
FXB3-220/120SB		2160	6125	1920	720	648	1140	1190	9.8
FXB4-230/120SB		2300	7595	2060	760	680	1220	1250	11.8
FXB5-230/120SB		2400	8575	2160	810	720	1280	1340	14.1
FXB6-230/120SB		2700	9800	2460	910	820	1440	1500	15.8
FXB2-330/120SB	330/345	2780	7260	2540	950	850	1460	1510	10.7
FXB3-330/120SB		2780	9100	2540	950	850	1460	1510	13.9
FXB2-400/120SB	400	3350	8400	3100	1100	960	1850	1900	12.2
FXB3-400/120SB		3380	10500	3130	1120	980	1870	1920	16.2
FXB4-400/120SB		3380	13020	3130	1120	980	1870	1920	20.6
FXB2-500/120SB	500	4050	11000	3800	1310	1110	2260	2310	15.5
FXB3-500/120SB		4050	13750	3800	1310	1110	2260	2310	21.8
FXB4-500/120SB		4300	17050	4050	1380	1180	2350	2400	27.7

Note: 1. All tests are in accordance with IEC61109;

2. All units for 220kV system voltage should be assembled one corona ring at the line end.

3. For other fittings, use the suffixes indicated above. Specify the top fitting first. For example: for clevis top and tongue bottom, add the suffix CT instead of the suffix SB. If both end fittings are to be same, just specify one letter.

Example: for clevis at both end, just add C suffix instead of the suffix SB .

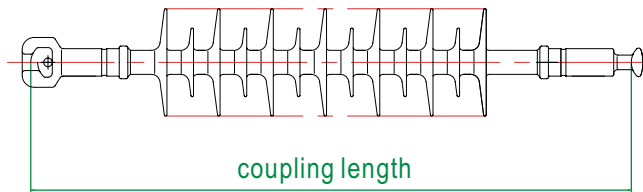
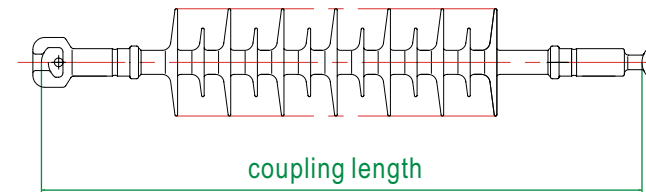
TONLY™ SUSPENSION COMPOSITE INSULATORS

TONLY™ SUSPENSION COMPOSITE INSULATORS

CHARACTERISTICS
SML:160kN

Catalogue Number	Normal system volt. (kV)	Approx. Dimensions (mm)			Electrical Ratings				Net Weight (kg)
		Coupling length	Min. Creepage distance	Dry arc distance	Power freq. Flashover (kV)		Impulse Flashover (kV)		
					Dry	Wet	Pos.	Neg.	
FXB2-132/160SB	132/138	1380	2900	1100	420	380	680	700	8.5
FXB3-132/160SB		1500	3625	1220	460	410	740	760	10
FXB4-132/160SB		1580	4495	1300	480	430	780	800	12
FXB5-132/160SB		1740	5800	1460	530	470	850	900	13.5
FXB2-154/160SB	154	1606	3080	1326	500	450	810	850	9
FXB4-154/160SB		1752	5184	1472	550	490	890	920	12.5
FXB2-220/160SB	220/230	2200	4900	1920	720	648	1140	1190	12.6
FXB3-230/160SB		2280	6125	2000	740	660	1180	1220	14.4
FXB4-230/160SB		2320	7595	2040	760	680	1220	1250	16.7
FXB5-230/160SB		2440	8575	2160	810	720	1280	1340	19
FXB6-230/160SB		2740	9800	2460	910	820	1440	1500	21
FXB2-330/160SB		330/345	2840	7260	2560	960	860	1480	1530
FXB3-330/160SB	2840		9100	2560	960	860	1480	1530	19.4
FXB2-400/160SB	400	3910	8400	3600	1210	1020	2150	2200	19.5
FXB3-400/160SB		3910	10500	3600	1210	1020	2150	2200	22.5
FXB4-400/160SB		3910	13020	3600	1120	980	2150	2200	26.7
FXB2-500/160SB	500	4110	11000	3800	1310	1110	2260	2310	23
FXB3-500/160SB		4110	13750	3800	1310	1110	2260	2310	28
FXB4-500/160SB		4510	17050	4200	1380	1180	2350	2400	33.7

Note: 1. All tests are in accordance with IEC61109;

2. All units for 220kV system voltage should be assembled one corona ring at the line end.

All units for 400kV or greater system voltage should be assembled with two corona rings, one at each end.

3. For other fittings, use the suffixes indicated above. Specify the top fitting first. For example: for clevis top and tongue bottom, add the suffix CT instead of the suffix SB. If both end fittings are to be same, just specify one letter.

Example: for clevis at both end, just add C suffix instead of the suffix SB .

CHARACTERISTICS
SML:210kN

Catalogue Number	Normal system volt. (kV)	Approx. Dimensions (mm)			Electrical Ratings				Net Weight (kg)
		Coupling length	Min. Creepage distance	Dry arc distance	Power freq. Flashover (kV)		Impulse Flashover (kV)		
					Dry	Wet	Pos.	Neg.	
FXB2-132/210SB	132/138	1410	2900	1100	420	380	680	700	8.7
FXB3-132/210SB		1530	3625	1220	460	410	740	760	10.2
FXB4-132/210SB		1610	4495	1300	480	430	780	800	12.2
FXB5-132/210SB		1770	5800	1460	530	470	850	900	13.7
FXB2-230/210SB	220/230	2230	4900	1920	720	648	1140	1190	12.8
FXB3-230/210SB		2310	6125	2000	740	660	1180	1220	14.6
FXB4-230/210SB		2350	7595	2040	760	680	1220	1250	16.9
FXB5-230/210SB		2470	8575	2160	810	720	1280	1340	19.2
FXB6-230/210SB	330/345	2770	9800	2460	910	820	1440	1500	21.2
FXB2-345/210SB		3060	7820	2720	980	860	1580	1630	17.5
FXB4-345/210SB	400	3060	12100	2720	980	860	1580	1630	27.5
FXB2-400/210SB		3910	8400	3570	1210	1020	2150	2200	19.7
FXB3-400/210SB		3910	10500	3570	1210	1020	2150	2200	22.7
FXB4-400/210SB		3910	13020	3570	1120	980	2150	2200	26.9
FXB5-400/210SB		3980	14700	3640	1180	1010	2190	2240	29.6
FXB6-400/210SB		4080	16800	3740	1250	1060	2210	2260	36.9
FXB2-500/210SB	500	4140	11000	3800	1310	1110	2260	2310	23.2
FXB3-500/210SB		4140	13750	3800	1310	1110	2260	2310	28.2
FXB4-500/210SB		4540	17050	4200	1380	1180	2350	2400	33.9

Note: 1. All tests are in accordance with IEC61109;

2. All units for 220kV system voltage should be assembled one corona ring at the line end.

All units for 400kV or greater system voltage should be assembled with two corona rings, one at each end.

3. For other fittings, use the suffixes indicated above. Specify the top fitting first. For example: for clevis top and tongue bottom, add the suffix CT instead of the suffix SB. If both end fittings are to be same, just specify one letter.

Example: for clevis at both end, just add C suffix instead of the suffix SB .

TONLY™ SUSPENSION COMPOSITE INSULATORS

CHARACTERISTICS

SML:300kN

Catalogue Number	Normal system volt. (kV)	Approx. Dimensions (mm)			Electrical Ratings				Net Weight (kg)
		Coupling length	Min. Creepage distance	Dry arc distance	Power freq. Flashover (kV)		Impulse Flashover (kV)		
					Dry	Wet	Pos.	Neg.	
FXB2-345/300SB	330/345	3315	7820	2975	980	860	1580	1630	20.4
FXB4-345/300SB		3510	12100	3170	980	860	1580	1630	28.4
FXB2-400/300SB	400	3910	8400	3570	1210	1020	2150	2200	23.6
FXB3-400/300SB		3910	10500	3570	1210	1020	2150	2200	26.2
FXB4-400/300SB	500	3910	13020	3570	1120	980	2150	2200	31
FXB2-500/300SB		4140	11000	3800	1310	1110	2260	2310	26.6
FXB3-500/300SB		4140	13750	3800	1310	1110	2260	2310	32
FXB4-500/300SB		4540	17050	4200	1380	1180	2350	2400	41.2

Note: 1. All tests are in accordance with IEC61109;

2. All units for 220kV system voltage should be assembled one corona ring at the line end. All units for 400kV or greater system voltage should be assembled with two corona rings, one at each end.

3. For other fittings, use the suffixes indicated above. Specify the top fitting first. For example: for clevis top and tongue bottom, add the suffix CT instead of the suffix SB. If both end fittings are to be same, just specify one letter.

Example: for clevis at both end, just add C suffix instead of the suffix SB.

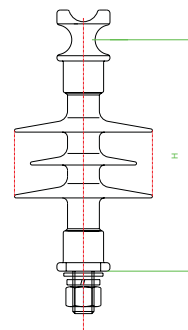

TONLY™ PIN TYPE COMPOSITE INSULATORS

CHARACTERISTICS

Catalogue Number	Normal system volt. (KV)	Approx. Dimensions (mm)			Electrical Ratings				Diameter of core (mm)	MDCL (KN)
		Height H	Min. Creepage distance	Dry arc distance	Power freq. Flashover (KV)		Impulse Flashover (KV)			
					Dry	Wet	Pos.	Neg.		
PIN2-22/5.5	22	320	480	175	80	60	130	135	34	5.5
PIN3-22/5.5		320	600	175	80	60	130	135	34	5.5
PIN4-22/5.5		460	770	290	110	90	190	200	38	5.5
PIN2-33/6	33/35	500	720	330	140	120	220	230	45	6
PIN3-33/6		500	900	330	140	120	220	230	45	6
PIN4-33/6		580	1116	410	170	150	280	290	50	6
PIN5-33/6		580	1440	410	170	150	280	290	50	6

Note: 1. All tests are in accordance with IEC61952

2. Dimensions of the tie top head and the mounting stud will be in accordance with the customer's requirement.



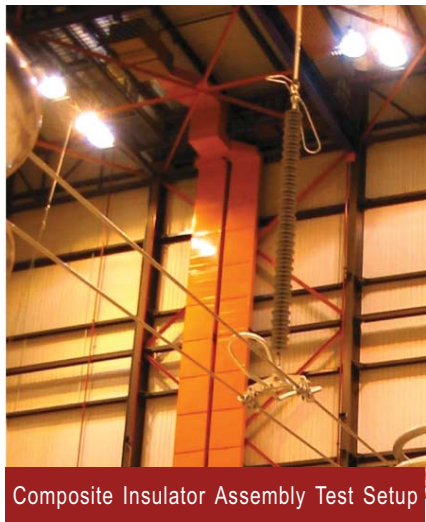
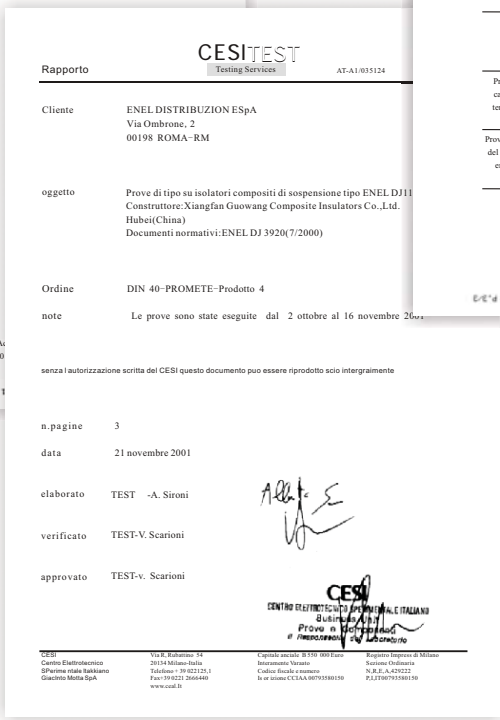
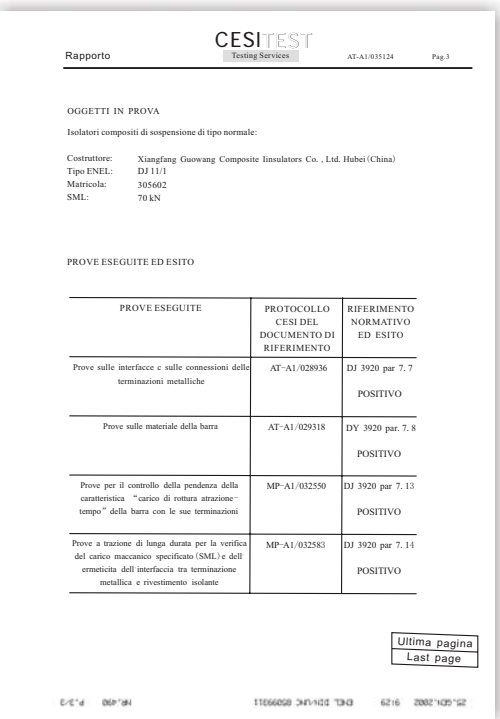
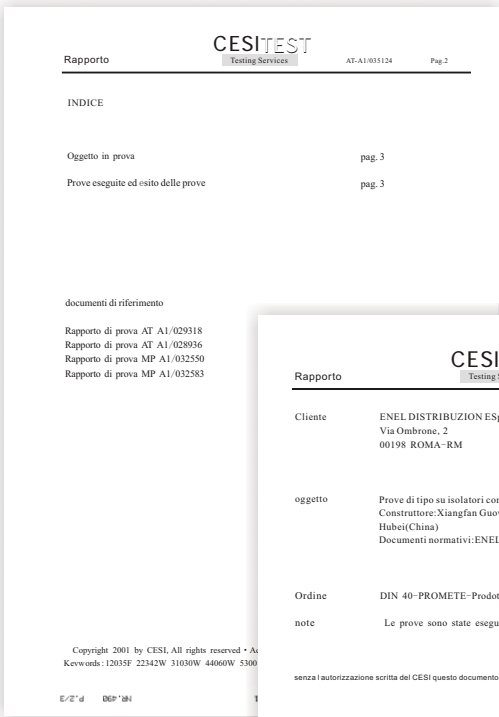
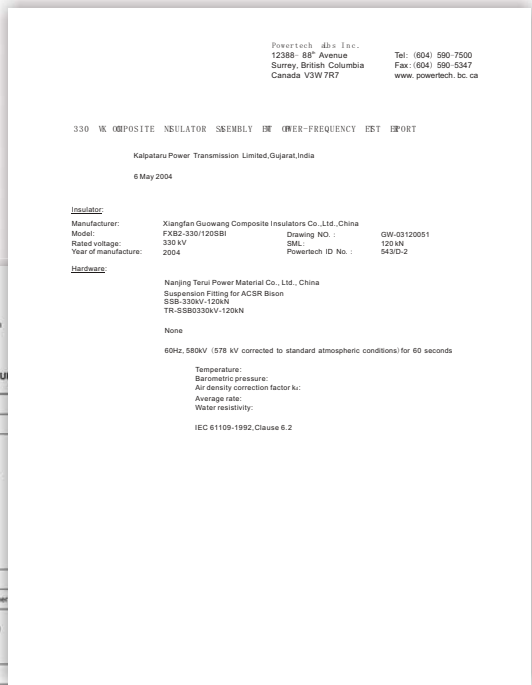

Each performance index of series products achieved the national standard and IEC standard, and passed the type test of authoritative third party (State Grid Electric Power Research Institute and China Electric Power Research Institute of China). TONLY™ composite insulator has passed the aging test under operating voltage simulating weather conditions in KEMA laboratory of Netherlands, the type test in Powertech laboratory of Canada and CESI laboratory of Italy.

Company History

In 1987, Xiangfan Electric Power Equipments Factory decided to develop and produce the composite insulator.

In 1988, the first composite insulator of China was produced in Xiangfan Electric Power Equipments Factory.

In June 1991, TONLY™ 500kV composite insulators were put into operation in Gezhou Dam-Shuanghe transmission line, which filled the gap in the field of domestic high voltage composite insulators.

In June 1991, large-tonnage 500kV composite insulator won the gold prize of "National Torch High Technology and Product Exhibition Conference"

In 1993, 500KV composite insulator was assessed as "National New Product" by National Science and Technology Commission.

In 1997, Xiangfan Company passed ISO9002 International Quality System Certification and 220kV product quality certification in the same industry in China.

In 1997, Xiangfan Guowang Composite Insulators Co., Ltd was established which was specialized in developing and producing composite insulators.

In October 1999, the products of Xiangfan Guowang Composite Insulators Co. Ltd. passed 5000 hours aging test under operating voltage simulating weather conditions in KEMA lab of Netherlands.

In 2001, the company exported 72,300 pcs composite insulators to Italy, which inaugurated a new era in the same industry. Since then, the products had being exported to more than 20 countries such as, the Netherlands, India, Chile, Iran and so on.

In November 2001, the products of Xiangfan Guowang Company passed the type test in CESI lab of Italy.

In September 2006, 1000kV and ±800kV Extra High Voltage composite insulators passed the technical appraisal, and all of the experts had a same opinion that the TONLY™ Extra High Voltage AC & DC composite insulators had reached the international advanced level.

In March 2007, the new plant of Xiangfan Guowang Composite Insulators Co.,Ltd went into operation.

In June 2007, the delegation from Power Grid Corporation of India visited to Xiangfan Guowang Composite Insulators Co. Ltd.

In December 2007, 1000KV AC composite insulator which produced by Xiangfan Guowang Composite Insulators Co. Ltd won national key new product certificate.

In March 2008, the railway composite insulator produced by Xiangfan Guowang Composite Insulators Co., Ltd passed science technology achievements appraisal. The technology of railway composite insulator was assessed as to reach advanced level at home and abroad.

In August 2008, Xiangfan Guowang Composite Insulators Co. Ltd took the lead in passing Environmental Management System, Occupational Health and Safety Management System.

In March 2009, Xiangfan Guowang Composite Insulator Co., Ltd. was assessed as key high-tech enterprise of "National Torch Plan".

In May 2009, Xiangfan Guowang Composite Insulators Co.,Ltd was invited to participate in "2009 INMR WORLD CONGRESS"

In May 2009, Xiangfan Guowang Company which its 1000kV Extra High Voltage composite insulator was assessed as national independent innovation product.

In 2010, Xiangfan Guowang Composite Insulators Co. Ltd expand production capacity once again, we will build a new injection molding production line and then we will have annually production capacity of 2,000,000 pcs of standard composite insulators.



TONLY™ Composite Insulator has markets in 31 provinces of China and it's exported to Britain, Netherlands, Italy, Greece, Cyprus, Turkey, India, Vietnam, Philippines, Cambodia, Afghanistan, Korea, Jordan, Iran, Saudi Arabia, Oman, United Arab Emirates, Morocco, Ethiopia, Zambia, Mexico, Colombia, Brazil, Peru, Chile, Australia and so on.

Our business line covers all over the world